



# PanAm Series I

SUN 29 MAY 2022

Black Belt Tiger (8-9) / Boys -30kg Contestants: 3



Semifinals

Final

Semifinals

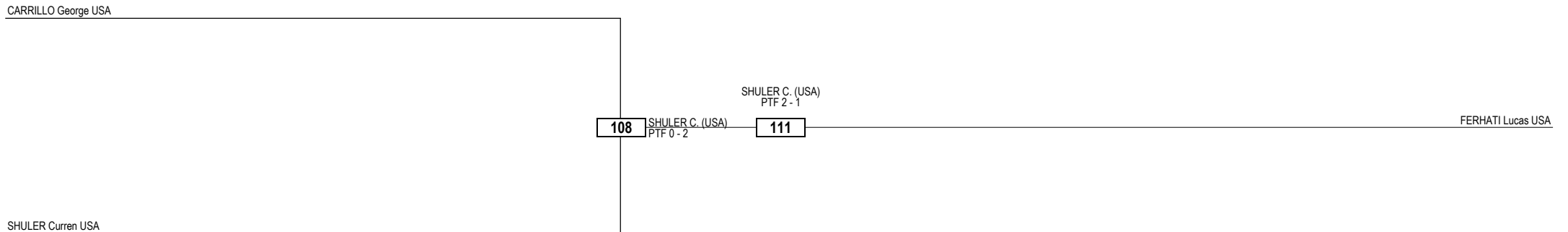

Classification
1 SHULER Curren (USA)
2 FERHATI Lucas (USA)
3 CARRILLO George (USA)

<b>LEGEND</b>	RSC: Win by Referee Stop Contest	PTG: Win by Point Gap	SUP: Win by Superiority	DSQ: Win by Disqualification	DQB: Win by Disqualification for unsportsmanlike behavior	DWR: Double Withdrawal	R: Round
(x) <b>Seed</b>	PTF: Win by Final Score	GDP: Win by Golden Points	WDR: Win by Withdrawal	PUN: Win by Punitive Declaration	DDB: Double Disqualification for unsportsmanlike behavior	DDQ: Double Disqualification	



PanAm Series I  
 SUN 29 MAY 2022  
 Black Belt Youth / Boys -40kg Contestants: 2



Final

MINER Brady USA

MINER B. (USA)  
 PTF 2 - 0

103

SA Royce USA

Classification
1 MINER Brady (USA)
2 SA Royce (USA)

<b>LEGEND</b>	RSC: Win by Referee Stop Contest	PTG: Win by Point Gap	SUP: Win by Superiority	DSQ: Win by Disqualification	DQB: Win by Disqualification for unsportsmanlike behavior	DWR: Double Withdrawal	R: Round
<b>(x) Seed</b>	PTF: Win by Final Score	GDP: Win by Golden Points	WDR: Win by Withdrawal	PUN: Win by Punitive Declaration	DDB: Double Disqualification for unsportsmanlike behavior	DDQ: Double Disqualification	



PanAm Series I  
 SUN 29 MAY 2022  
 Red Belt Youth / Boys -35kg Contestants: 2



Final

ESCAMILLA Axel USA

ESCAMILLA A. (USA)  
 PTF 2 - 1

106

RINEBOLD Hayes USA

Classification
1 ESCAMILLA Axel (USA)
2 RINEBOLD Hayes (USA)

<b>LEGEND</b>	RSC: Win by Referee Stop Contest	PTG: Win by Point Gap	SUP: Win by Superiority	DSQ: Win by Disqualification	DQB: Win by Disqualification for unsportsmanlike behavior	DWR: Double Withdrawal	R: Round
<b>(x) Seed</b>	PTF: Win by Final Score	GDP: Win by Golden Points	WDR: Win by Withdrawal	PUN: Win by Punitive Declaration	DDB: Double Disqualification for unsportsmanlike behavior	DDQ: Double Disqualification	



# PanAm Series I

SUN 29 MAY 2022

Black Belt Youth / Boys -35kg Contestants: 5



Quarterfinals    Semifinals    Final    Semifinals    Quarterfinals

GEOFROY Kevin USA

GRIMALDO Eli USA

**107** LEPE J. (USA)  
PTF 0 - 2

LEPE Joshua USA

LEPE J. (USA)  
PTF 2 - 0

**109** LEPE J. (USA)  
PTF 2 - 0

**112**

WAHL T. (USA)  
PTF 1 - 2    **110**

DULIN Kamden USA

WAHL Tyler USA

Classification
1 LEPE Joshua (USA)
2 WAHL Tyler (USA)
3 DULIN Kamden (USA)
3 GRIMALDO Eli (USA)

<b>LEGEND</b>	RSC: Win by Referee Stop Contest	PTG: Win by Point Gap	SUP: Win by Superiority	DSQ: Win by Disqualification	DQB: Win by Disqualification for unsportsmanlike behavior	DWR: Double Withdrawal	R: Round
<b>(x) Seed</b>	PTF: Win by Final Score	GDP: Win by Golden Points	WDR: Win by Withdrawal	PUN: Win by Punitive Declaration	DDB: Double Disqualification for unsportsmanlike behavior	DDQ: Double Disqualification	



PanAm Series I  
 SUN 29 MAY 2022  
 Blue Belt Youth / Boys -35kg Contestants: 2



Final

LIMOSNERO Noah USA

LAI KOUN SING A. (FPO)  
 PTF 0 - 2

105

LAI KOUN SING Andrew FPO

Classification
1 LAI KOUN SING Andrew (FPO)
2 LIMOSNERO Noah (USA)

<b>LEGEND</b>	RSC: Win by Referee Stop Contest	PTG: Win by Point Gap	SUP: Win by Superiority	DSQ: Win by Disqualification	DQB: Win by Disqualification for unsportsmanlike behavior	DWR: Double Withdrawal	R: Round
(x) <b>Seed</b>	PTF: Win by Final Score	GDP: Win by Golden Points	WDR: Win by Withdrawal	PUN: Win by Punitive Declaration	DDB: Double Disqualification for unsportsmanlike behavior	DDQ: Double Disqualification	



# PanAm Series I

SUN 29 MAY 2022

Black Belt Youth / Boys -30kg Contestants: 10



Round of 16    Quarterfinals    Semifinals    Final    Semifinals    Quarterfinals    Round of 16

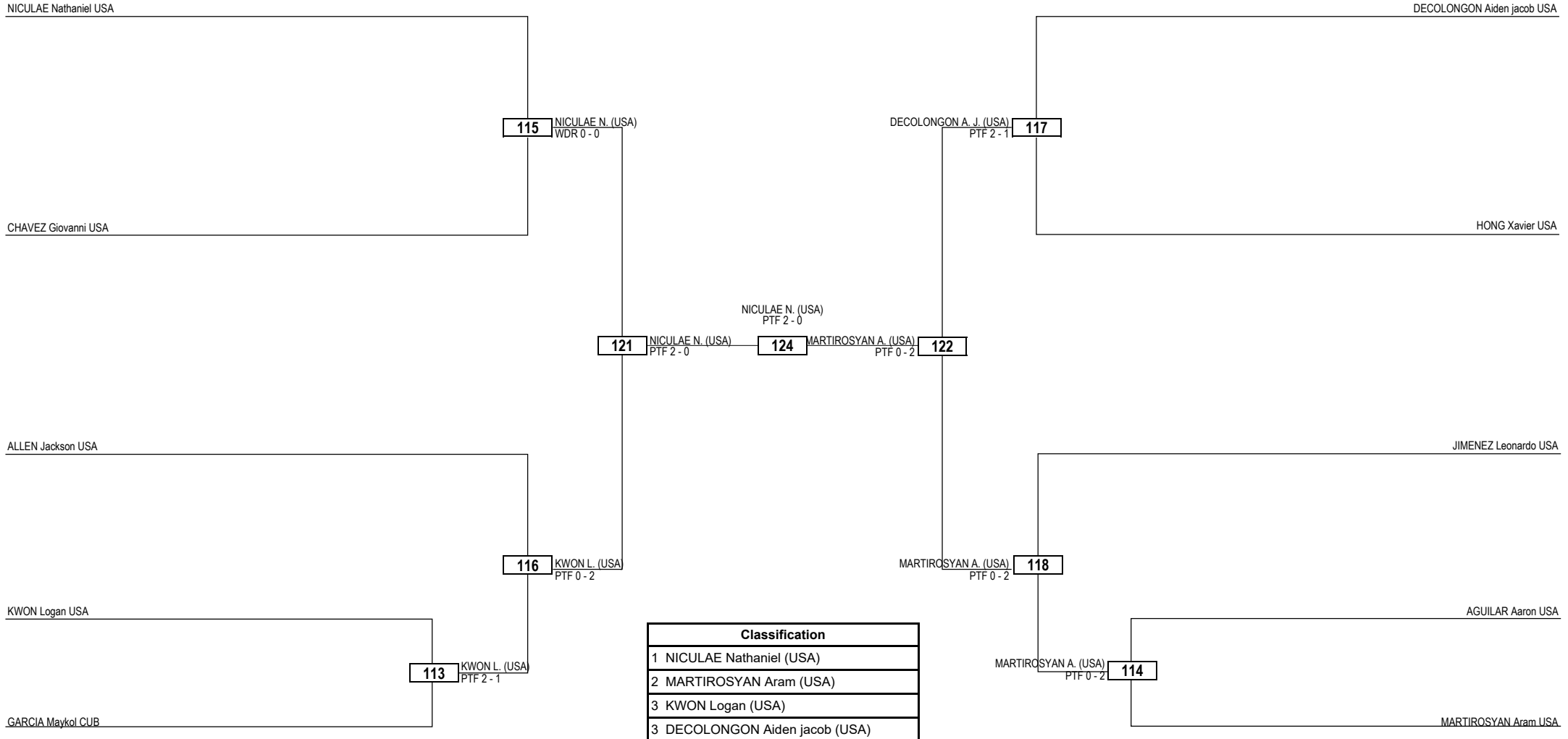

**LEGEND** RSC: Win by Referee Stop Contest    PTG: Win by Point Gap    SUP: Win by Superiority    DSQ: Win by Disqualification    DQB: Win by Disqualification for unsportsmanlike behavior    DWR: Double Withdrawal    R: Round  
 (x) **Seed**    PTF: Win by Final Score    GDP: Win by Golden Points    WDR: Win by Withdrawal    PUN: Win by Punitive Declaration    DDB: Double Disqualification for unsportsmanlike behavior    DDQ: Double Disqualification



PanAm Series I  
 SUN 29 MAY 2022  
 Black Belt Youth / Boys +40kg Contestants: 2



Final

MARTINEZ Adrian USA

MARTINEZ A. (USA)  
 PTF 2 - 1

104

QUAN Hieu USA

Classification
1 MARTINEZ Adrian (USA)
2 QUAN Hieu (USA)

<b>LEGEND</b>	RSC: Win by Referee Stop Contest	PTG: Win by Point Gap	SUP: Win by Superiority	DSQ: Win by Disqualification	DQB: Win by Disqualification for unsportsmanlike behavior	DWR: Double Withdrawal	R: Round
(x) <b>Seed</b>	PTF: Win by Final Score	GDP: Win by Golden Points	WDR: Win by Withdrawal	PUN: Win by Punitive Declaration	DDQ: Double Disqualification for unsportsmanlike behavior	DDQ: Double Disqualification	



# PanAm Series I

SUN 29 MAY 2022

Black Belt Youth / Girls +40kg Contestants: 3



Semifinals

Final

Semifinals

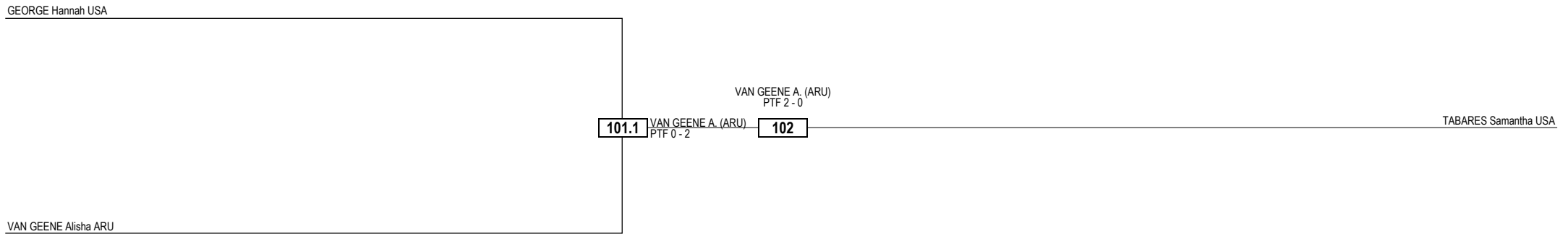

Classification
1 VAN GEENE Alisha (ARU)
2 TABARES Samantha (USA)
3 GEORGE Hannah (USA)

<b>LEGEND</b>	RSC: Win by Referee Stop Contest	PTG: Win by Point Gap	SUP: Win by Superiority	DSQ: Win by Disqualification	DQB: Win by Disqualification for unsportsmanlike behavior	DWR: Double Withdrawal	R: Round
(x) <b>Seed</b>	PTF: Win by Final Score	GDP: Win by Golden Points	WDR: Win by Withdrawal	PUN: Win by Punitive Declaration	DDB: Double Disqualification for unsportsmanlike behavior	DDQ: Double Disqualification	





PanAm Series I  
 SUN 29 MAY 2022  
 Black Belt Youth / Girls -35kg Contestants: 2



Final

MANALO Amber marie USA

ILASIN A. (USA)  
 PTF 0 - 2

101

ILASIN Arya USA

Classification
1 ILASIN Arya (USA)
2 MANALO Amber marie (USA)

<b>LEGEND</b>	RSC: Win by Referee Stop Contest	PTG: Win by Point Gap	SUP: Win by Superiority	DSQ: Win by Disqualification	DQB: Win by Disqualification for unsportsmanlike behavior	DWR: Double Withdrawal	R: Round
(x) <b>Seed</b>	PTF: Win by Final Score	GDP: Win by Golden Points	WDR: Win by Withdrawal	PUN: Win by Punitive Declaration	DDB: Double Disqualification for unsportsmanlike behavior	DDQ: Double Disqualification	



# PanAm Series I

SUN 29 MAY 2022

Black Belt Youth / Girls -30kg Contestants: 4



Semifinals

Final

Semifinals

HENDRIX Skylar USA

JUAREZ Camila USA

MICIANO MAYO J. (USA)  
PTF 0 - 2

119	HENDRIX S. (USA) PTF 2 - 0	123	MICIANO MAYO J. (USA) PTF 0 - 2	120
-----	-------------------------------	-----	------------------------------------	-----

HUBBARD Nisa USA

MICIANO MAYO Jessica USA

Classification	
1	MICIANO MAYO Jessica (USA)
2	HENDRIX Skylar (USA)
3	JUAREZ Camila (USA)
3	HUBBARD Nisa (USA)

<b>LEGEND</b>	RSC: Win by Referee Stop Contest	PTG: Win by Point Gap	SUP: Win by Superiority	DSQ: Win by Disqualification	DQB: Win by Disqualification for unsportsmanlike behavior	DWR: Double Withdrawal	R: Round
(x) <b>Seed</b>	PTF: Win by Final Score	GDP: Win by Golden Points	WDR: Win by Withdrawal	PUN: Win by Punitive Declaration	DDB: Double Disqualification for unsportsmanlike behavior	DDQ: Double Disqualification	



# PanAm Series I

SUN 29 MAY 2022

## Black Belt Cadets / Boys -45kg Contestants: 14



Round of 16    Quarterfinals    Semifinals    Final    Semifinals    Quarterfinals    Round of 16

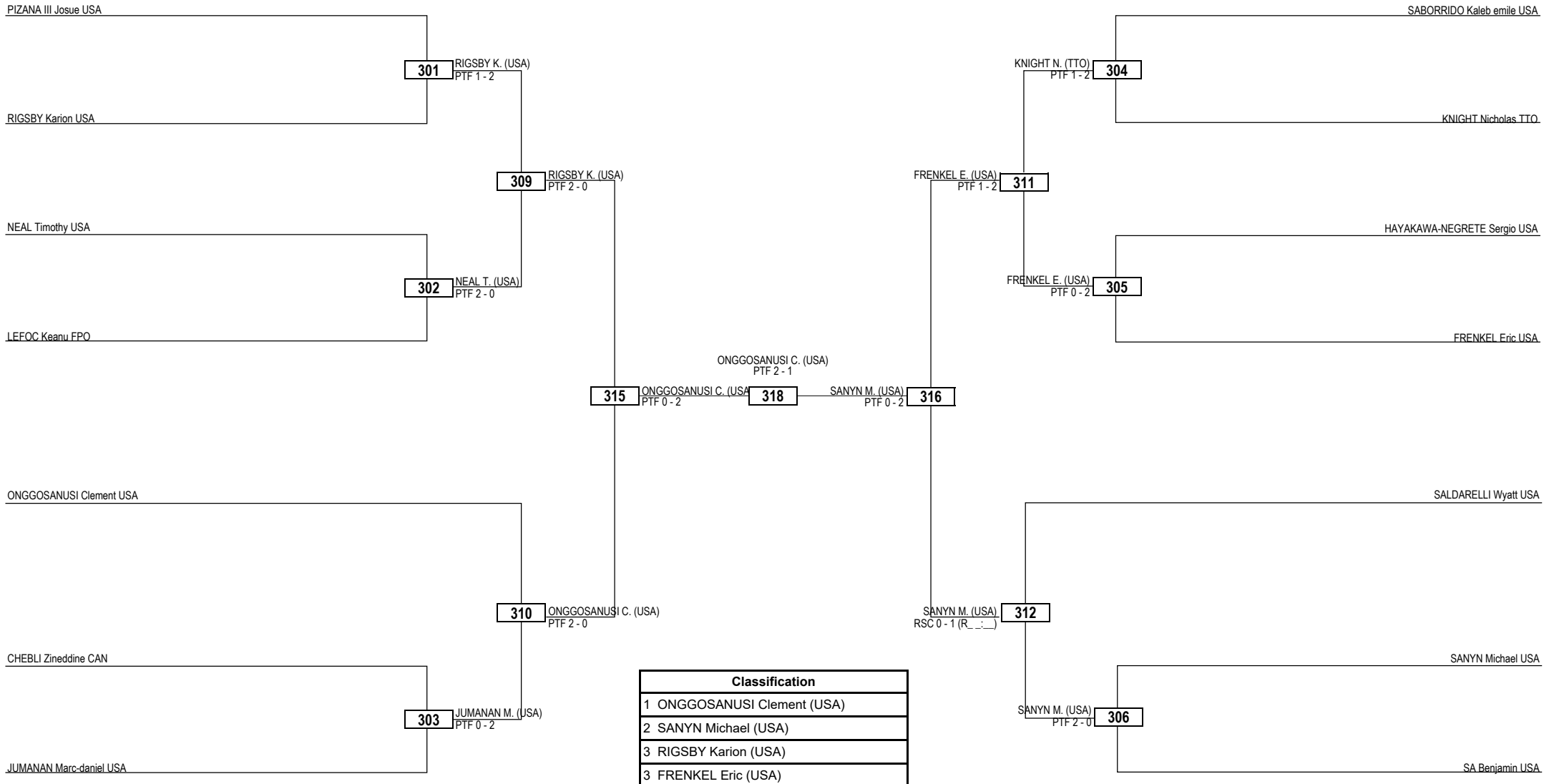

**LEGEND** RSC: Win by Referee Stop Contest    PTG: Win by Point Gap    SUP: Win by Superiority    DSQ: Win by Disqualification    DQB: Win by Disqualification for unsportsmanlike behavior    DWR: Double Withdrawal    R: Round  
**(x) Seed** PTF: Win by Final Score    GDP: Win by Golden Points    WDR: Win by Withdrawal    PUN: Win by Punitive Declaration    DDB: Double Disqualification for unsportsmanlike behavior    DDQ: Double Disqualification



PanAm Series I  
 SUN 29 MAY 2022  
 Black Belt Cadets / Boys -65kg Contestants: 2



Final

ROJAS Alexis fernando USA

DOMINGUEZ D. (USA)  
 PTF 0 - 2

407

DOMINGUEZ Diego USA

Classification
1 DOMINGUEZ Diego (USA)
2 ROJAS Alexis fernando (USA)

<b>LEGEND</b>	RSC: Win by Referee Stop Contest	PTG: Win by Point Gap	SUP: Win by Superiority	DSQ: Win by Disqualification	DQB: Win by Disqualification for unsportsmanlike behavior	DWR: Double Withdrawal	R: Round
(x) <b>Seed</b>	PTF: Win by Final Score	GDP: Win by Golden Points	WDR: Win by Withdrawal	PUN: Win by Punitive Declaration	DDB: Double Disqualification for unsportsmanlike behavior	DDQ: Double Disqualification	



# PanAm Series I

SUN 29 MAY 2022

Black Belt Cadets / Boys -61kg Contestants: 6



Quarterfinals    Semifinals    Final    Semifinals    Quarterfinals

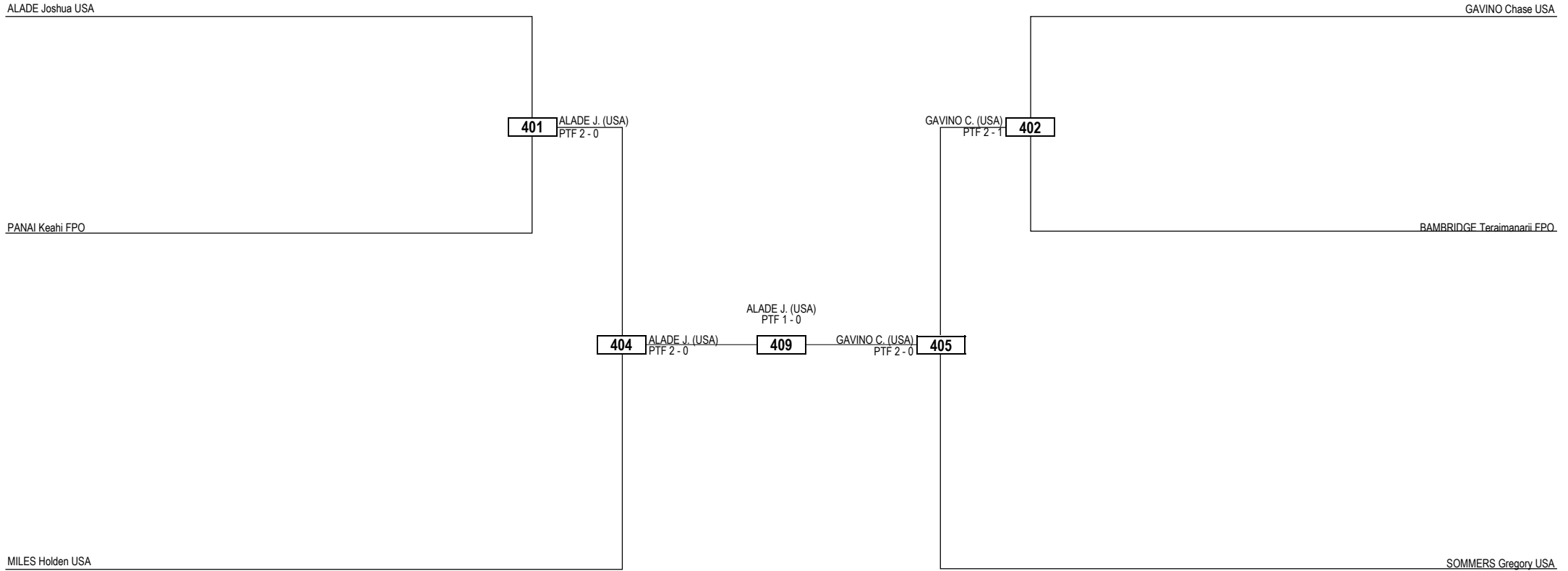

Classification
1 ALADE Joshua (USA)
2 GAVINO Chase (USA)
3 MILES Holden (USA)
3 SOMMERS Gregory (USA)

<b>LEGEND</b>	RSC: Win by Referee Stop Contest	PTG: Win by Point Gap	SUP: Win by Superiority	DSQ: Win by Disqualification	DQB: Win by Disqualification for unsportsmanlike behavior	DWR: Double Withdrawal	R: Round
(x) <b>Seed</b>	PTF: Win by Final Score	GDP: Win by Golden Points	WDR: Win by Withdrawal	PUN: Win by Punitive Declaration	DDB: Double Disqualification for unsportsmanlike behavior	DDQ: Double Disqualification	



# PanAm Series I

SUN 29 MAY 2022

Black Belt Cadets / Boys -57kg Contestants: 8



Quarterfinals   Semifinals   Final   Semifinals   Quarterfinals

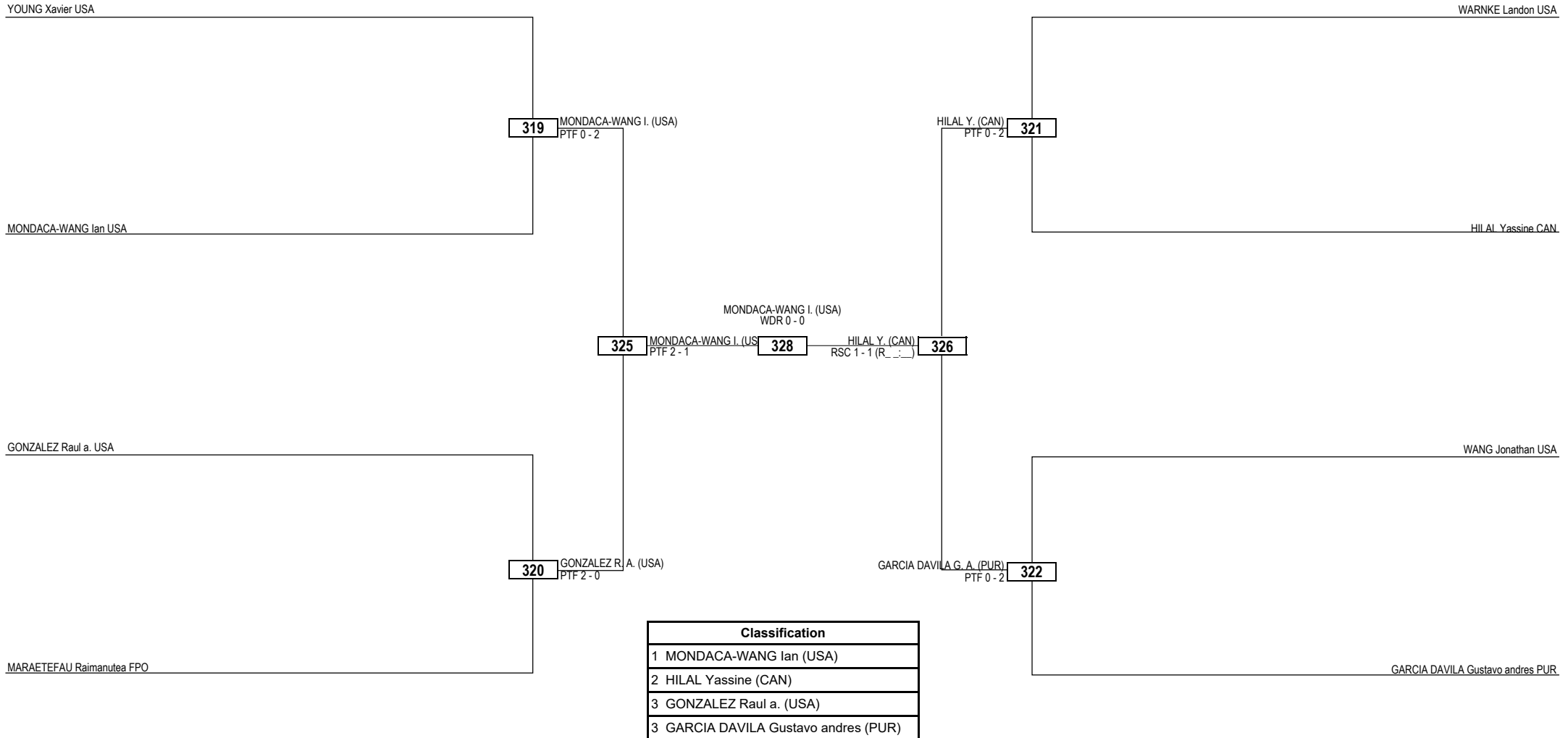

**LEGEND** RSC: Win by Referee Stop Contest    PTG: Win by Point Gap    SUP: Win by Superiority    DSQ: Win by Disqualification    DQB: Win by Disqualification for unsportsmanlike behavior    DWR: Double Withdrawal    R: Round  
 (x) Seed    PTF: Win by Final Score    GDP: Win by Golden Points    WDR: Win by Withdrawal    PUN: Win by Punitive Declaration    DDB: Double Disqualification for unsportsmanlike behavior    DDQ: Double Disqualification



# PanAm Series I

SUN 29 MAY 2022

Black Belt Cadets / Boys -53kg Contestants: 6



Quarterfinals    Semifinals    Final    Semifinals    Quarterfinals

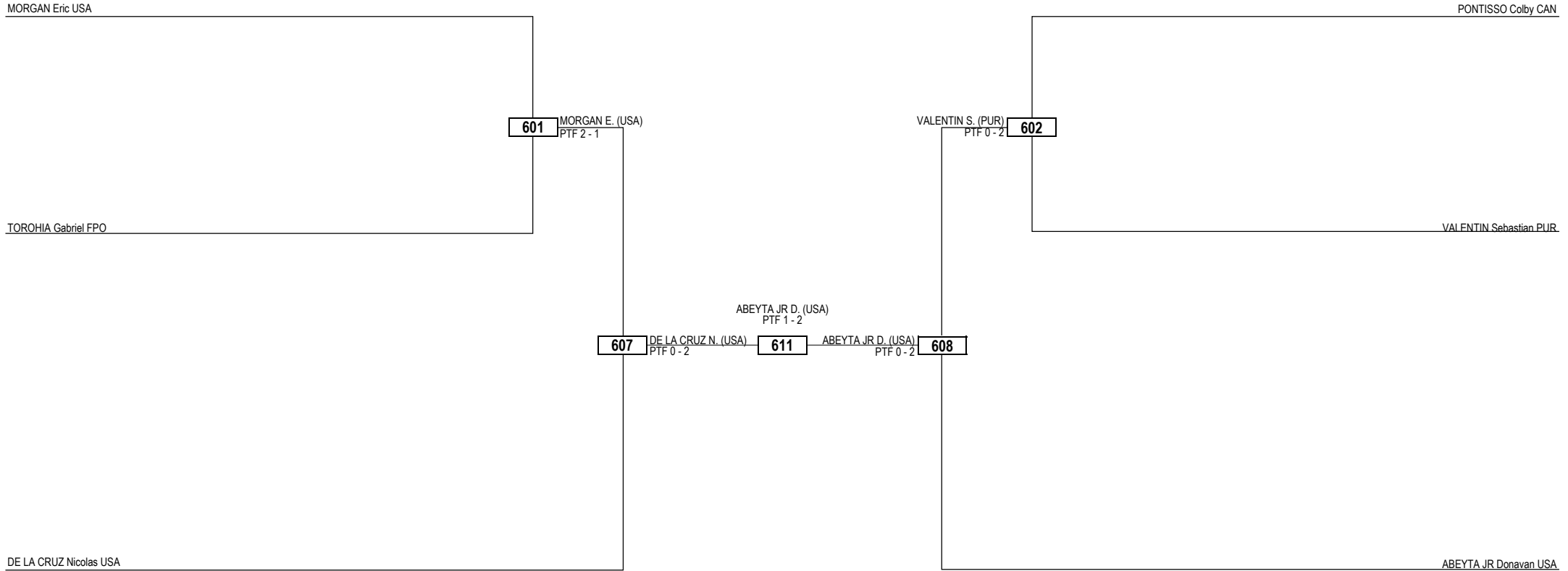

Classification
1 ABEYTA JR Donovan (USA)
2 DE LA CRUZ Nicolas (USA)
3 MORGAN Eric (USA)
3 VALENTIN Sebastian (PUR)

<b>LEGEND</b>	RSC: Win by Referee Stop Contest	PTG: Win by Point Gap	SUP: Win by Superiority	DSQ: Win by Disqualification	DQB: Win by Disqualification for unsportsmanlike behavior	DWR: Double Withdrawal	R: Round
<b>(x) Seed</b>	PTF: Win by Final Score	GDP: Win by Golden Points	WDR: Win by Withdrawal	PUN: Win by Punitive Declaration	DDB: Double Disqualification for unsportsmanlike behavior	DDQ: Double Disqualification	



# PanAm Series I

SUN 29 MAY 2022

## Black Belt Cadets / Boys -49kg Contestants: 11



Round of 16    Quarterfinals    Semifinals    Final    Semifinals    Quarterfinals    Round of 16

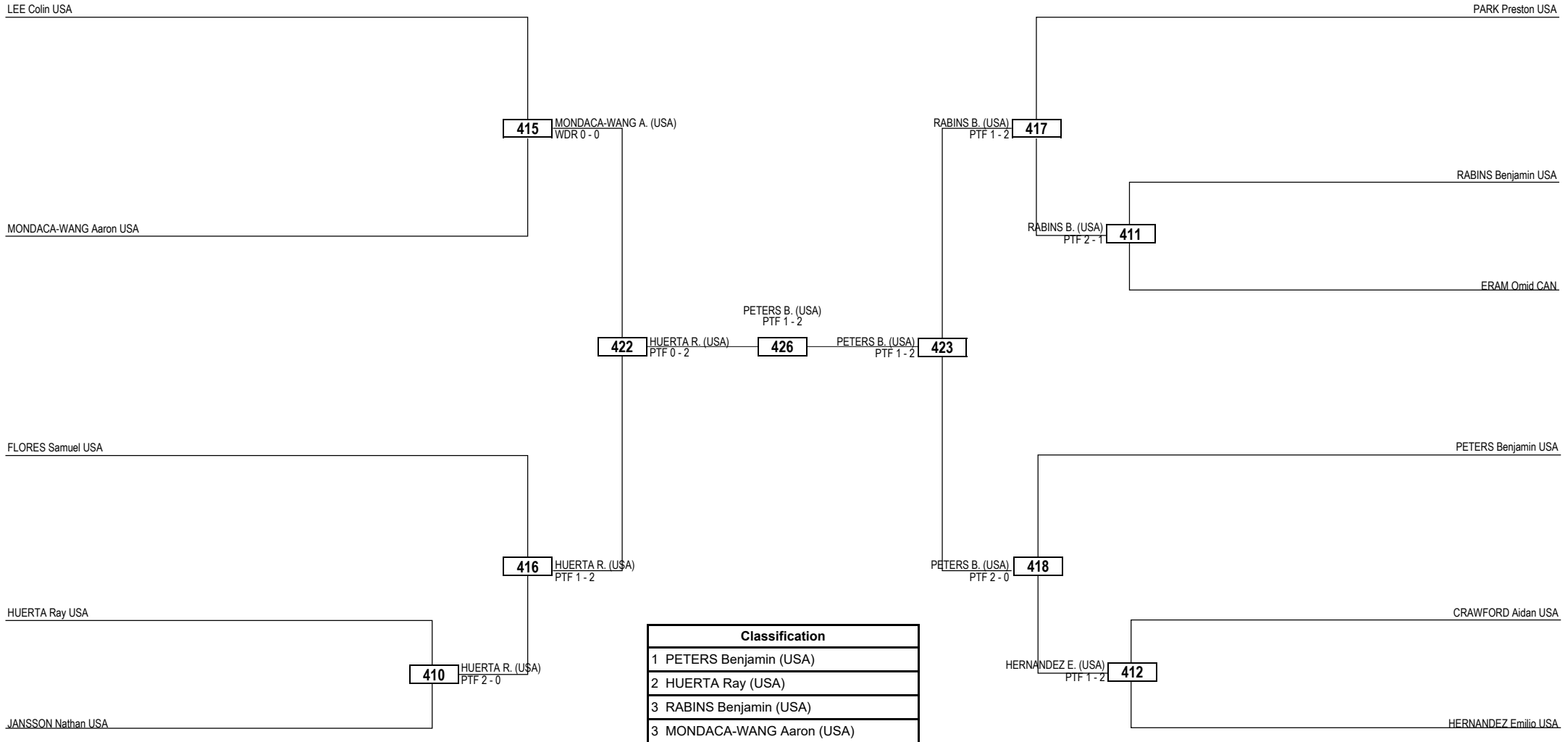

**LEGEND** RSC: Win by Referee Stop Contest    PTG: Win by Point Gap    SUP: Win by Superiority    DSQ: Win by Disqualification    DQB: Win by Disqualification for unsportsmanlike behavior    DWR: Double Withdrawal    R: Round  
 (x) **Seed**    PTF: Win by Final Score    GDP: Win by Golden Points    WDR: Win by Withdrawal    PUN: Win by Punitive Declaration    DDB: Double Disqualification for unsportsmanlike behavior    DDQ: Double Disqualification





# PanAm Series I

SUN 29 MAY 2022

Black Belt Cadets / Boys -41kg Contestants: 6



Quarterfinals   Semifinals   Final   Semifinals   Quarterfinals

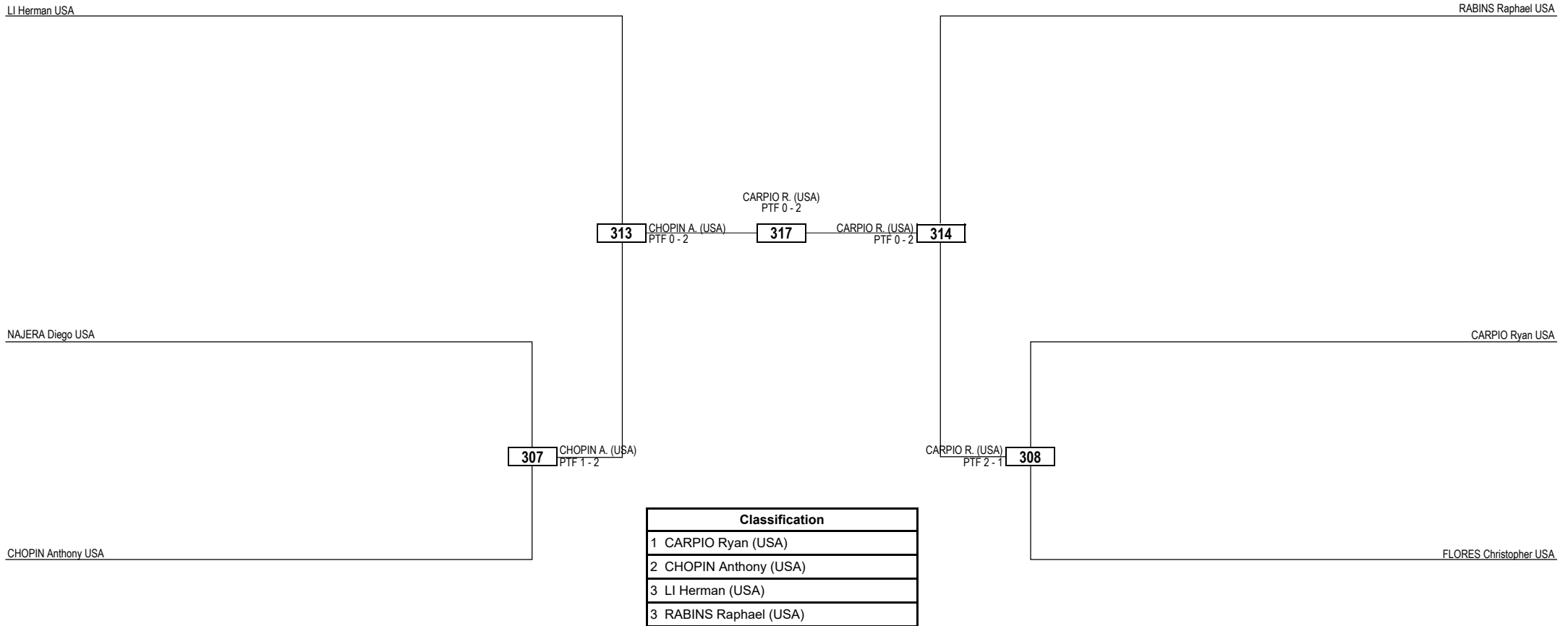

**LEGEND** RSC: Win by Referee Stop Contest    PTG: Win by Point Gap    SUP: Win by Superiority    DSQ: Win by Disqualification    DQB: Win by Disqualification for unsportsmanlike behavior    DWR: Double Withdrawal    R: Round  
**(x) Seed**    PTF: Win by Final Score    GDP: Win by Golden Points    WDR: Win by Withdrawal    PUN: Win by Punitive Declaration    DDB: Double Disqualification for unsportsmanlike behavior    DDQ: Double Disqualification



# PanAm Series I

SUN 29 MAY 2022

## Black Belt Cadets / Boys -37kg Contestants: 13



Round of 16    Quarterfinals    Semifinals    Final    Semifinals    Quarterfinals    Round of 16

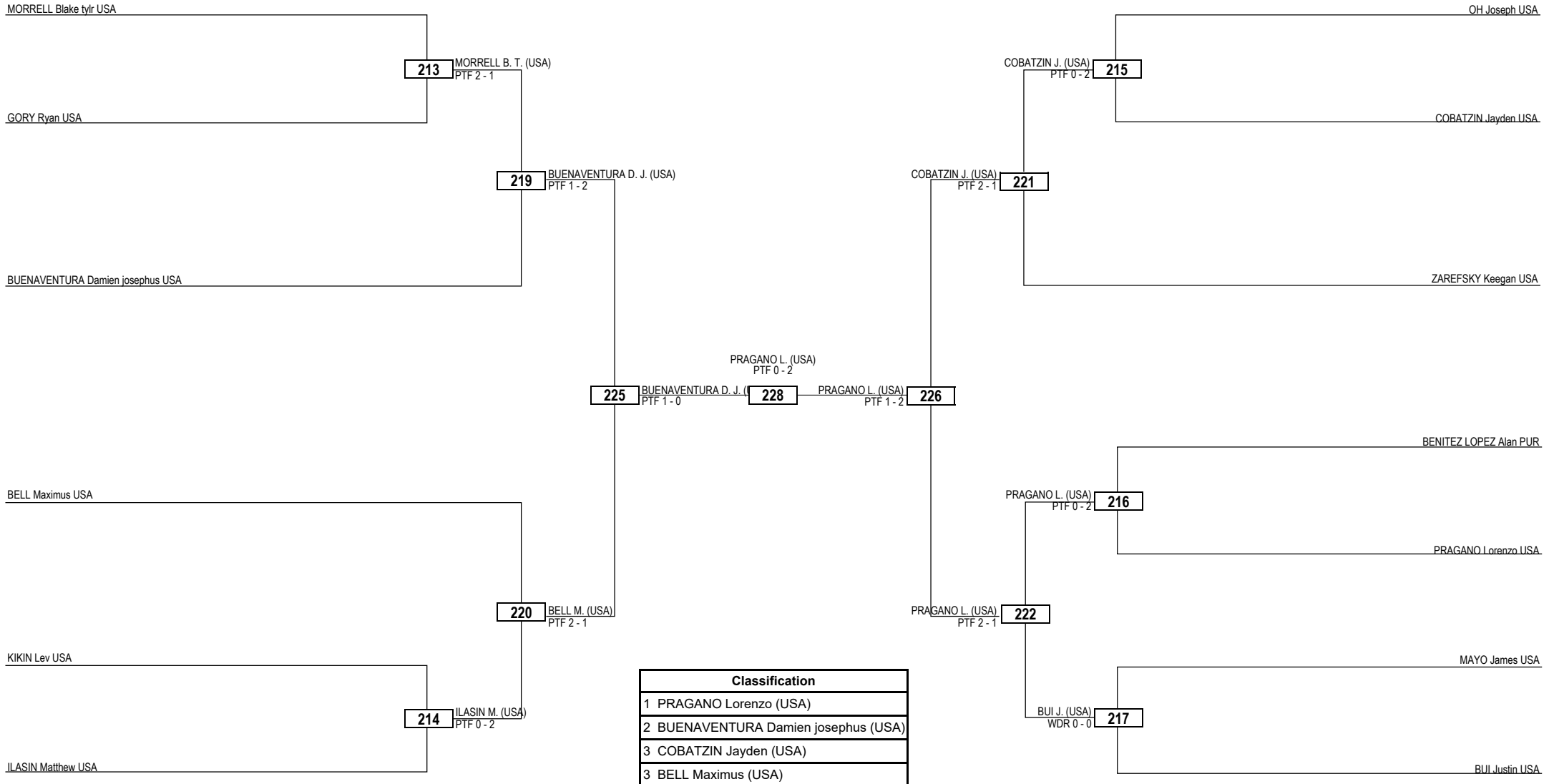

<b>LEGEND</b>	RSC: Win by Referee Stop Contest	PTG: Win by Point Gap	SUP: Win by Superiority	DSQ: Win by Disqualification	DQB: Win by Disqualification for unsportsmanlike behavior	DWR: Double Withdrawal	R: Round
<b>(x) Seed</b>	PTF: Win by Final Score	GDP: Win by Golden Points	WDR: Win by Withdrawal	PUN: Win by Punitive Declaration	DDB: Double Disqualification for unsportsmanlike behavior	DDQ: Double Disqualification	



# PanAm Series I

SUN 29 MAY 2022

Black Belt Cadets / Boys -33kg Contestants: 8



Quarterfinals   Semifinals   Final   Semifinals   Quarterfinals

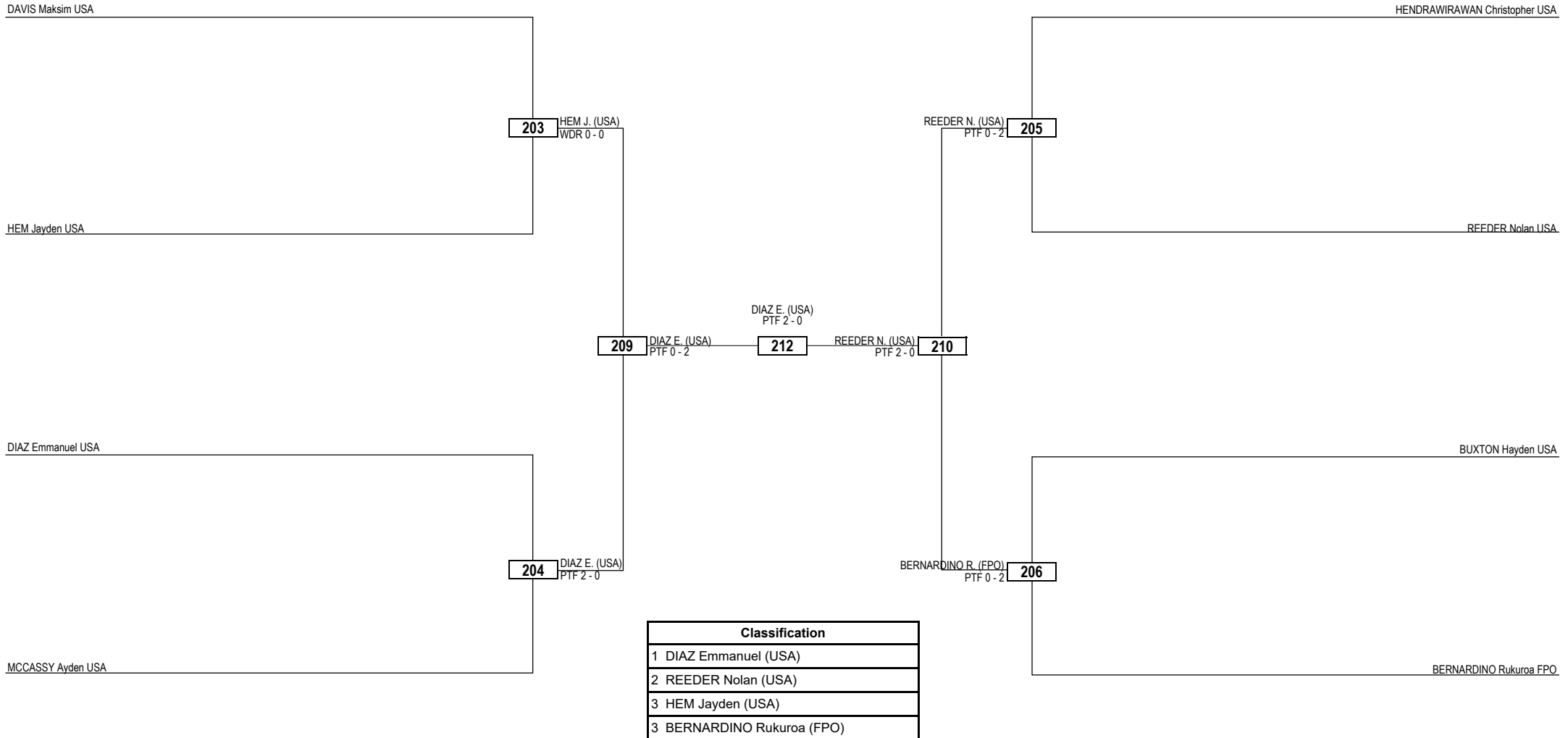

**LEGEND** RSC: Win by Referee Stop Contest    PTG: Win by Point Gap    SUP: Win by Superiority    DSQ: Win by Disqualification    DQB: Win by Disqualification for unsportsmanlike behavior    DWR: Double Withdrawal    R: Round  
**(x) Seed**    PTF: Win by Final Score    GDP: Win by Golden Points    WDR: Win by Withdrawal    PUN: Win by Punitive Declaration    DDB: Double Disqualification for unsportsmanlike behavior    DDQ: Double Disqualification



# PanAm Series I

SUN 29 MAY 2022

Black Belt Cadets / Boys +65kg Contestants: 4



Semifinals

Final

Semifinals

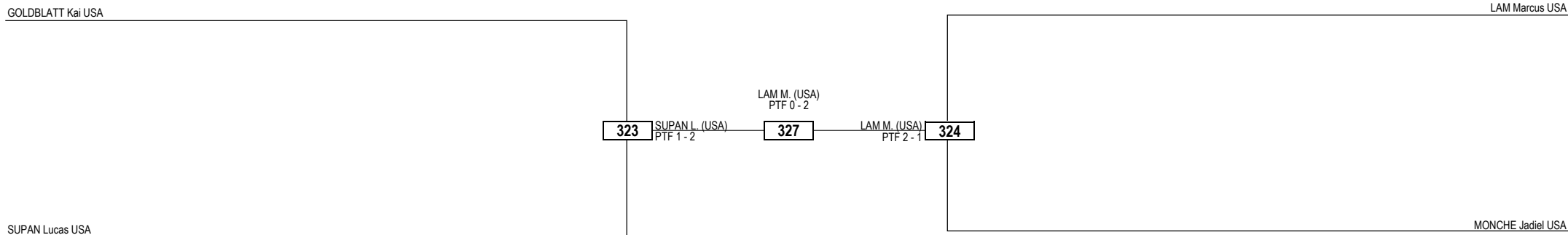

Classification
1 LAM Marcus (USA)
2 SUPAN Lucas (USA)
3 MONCHE Jadiel (USA)
3 GOLDBLATT Kai (USA)

<b>LEGEND</b>	RSC: Win by Referee Stop Contest	PTG: Win by Point Gap	SUP: Win by Superiority	DSQ: Win by Disqualification	DQB: Win by Disqualification for unsportsmanlike behavior	DWR: Double Withdrawal	R: Round
(x) <b>Seed</b>	PTF: Win by Final Score	GDP: Win by Golden Points	WDR: Win by Withdrawal	PUN: Win by Punitive Declaration	DDQ: Double Disqualification for unsportsmanlike behavior	DDQ: Double Disqualification	



# PanAm Series I

SUN 29 MAY 2022

Black Belt Cadets / Girls -47kg Contestants: 8



Quarterfinals   Semifinals   Final   Semifinals   Quarterfinals

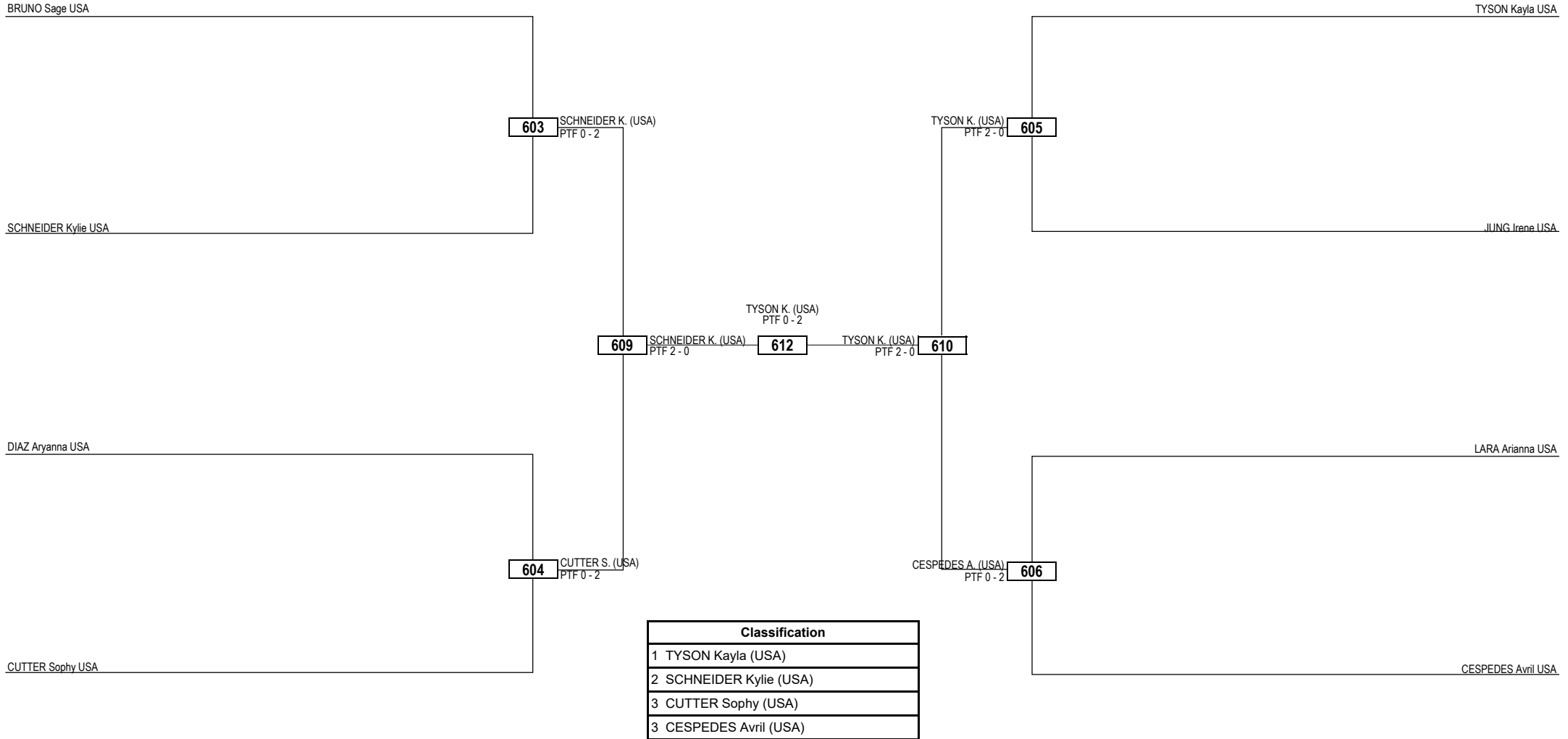

**LEGEND** RSC: Win by Referee Stop Contest    PTG: Win by Point Gap    SUP: Win by Superiority    DSQ: Win by Disqualification    DQB: Win by Disqualification for unsportsmanlike behavior    DWR: Double Withdrawal    R: Round  
**(x) Seed**    PTF: Win by Final Score    GDP: Win by Golden Points    WDR: Win by Withdrawal    PUN: Win by Punitive Declaration    DDB: Double Disqualification for unsportsmanlike behavior    DDQ: Double Disqualification



# PanAm Series I

SUN 29 MAY 2022

Black Belt Cadets / Girls -41kg Contestants: 7



Quarterfinals    Semifinals    Final    Semifinals    Quarterfinals

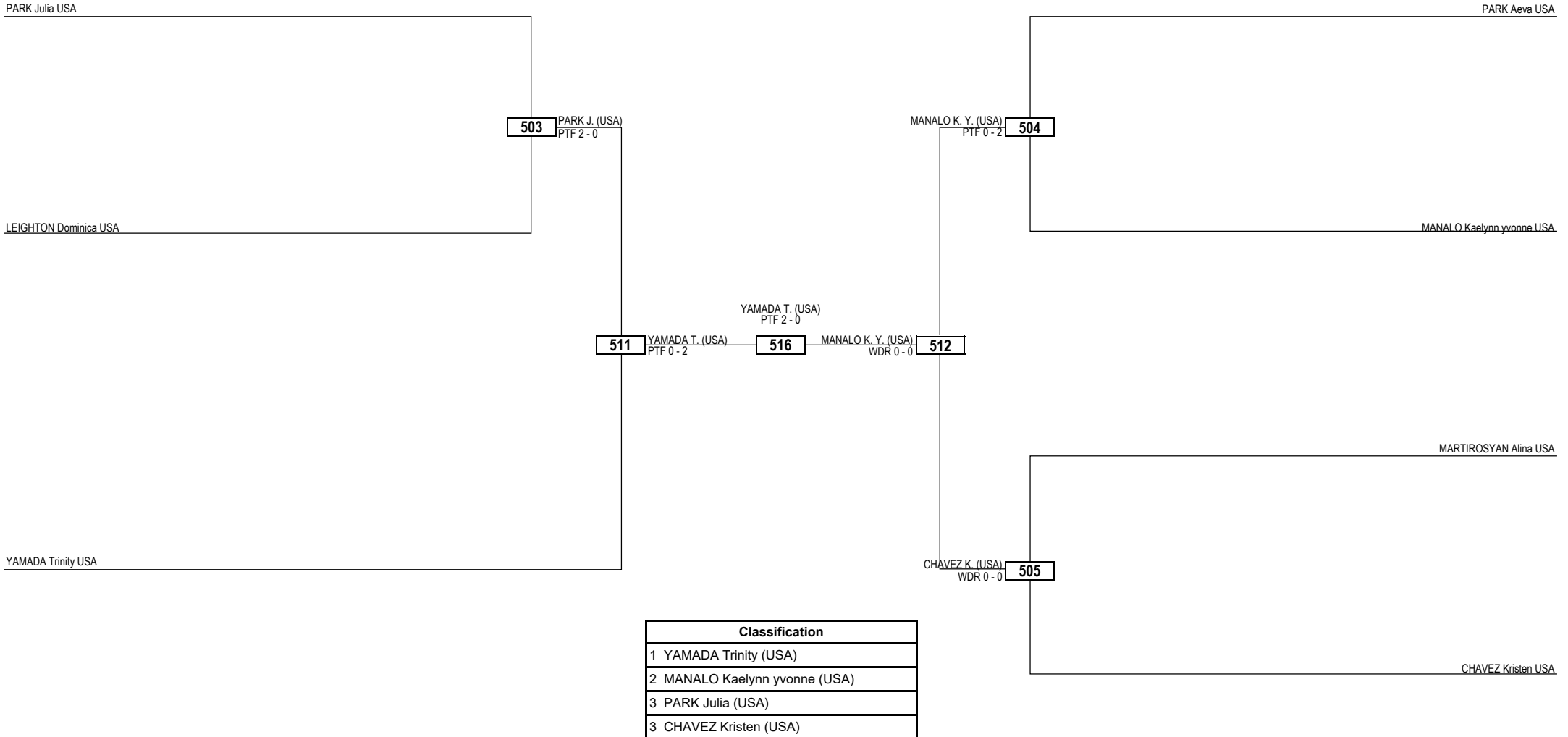

**LEGEND** RSC: Win by Referee Stop Contest    PTG: Win by Point Gap    SUP: Win by Superiority    DSQ: Win by Disqualification    DQB: Win by Disqualification for unsportsmanlike behavior    DWR: Double Withdrawal    R: Round  
 (x) Seed    PTF: Win by Final Score    GDP: Win by Golden Points    WDR: Win by Withdrawal    PUN: Win by Punitive Declaration    DDB: Double Disqualification for unsportsmanlike behavior    DDQ: Double Disqualification



# PanAm Series I

SUN 29 MAY 2022

Black Belt Cadets / Girls -59kg Contestants: 3



Semifinals

Final

Semifinals

ESTRADA Valeria USA

HANERE T. (FPO)  
PTF 0 - 2

408

HANERE T. (FPO)  
PTF 2 - 0

403

HANERE Tevanira FPO

PALMER Sofia USA

Classification
1 HANERE Tevanira (FPO)
2 ESTRADA Valeria (USA)
3 PALMER Sofia (USA)

**LEGEND** RSC: Win by Referee Stop Contest  
**(x) Seed** PTF: Win by Final Score

PTG: Win by Point Gap  
 GDP: Win by Golden Points

SUP: Win by Superiority  
 WDR: Win by Withdrawal

DSQ: Win by Disqualification  
 PUN: Win by Punitive Declaration

DQB: Win by Disqualification for unsportsmanlike behavior  
 DDB: Double Disqualification for unsportsmanlike behavior

DWR: Double Withdrawal  
 DDQ: Double Disqualification

R: Round



# PanAm Series I

SUN 29 MAY 2022

Black Belt Cadets / Girls -55kg Contestants: 6



Quarterfinals   Semifinals   Final   Semifinals   Quarterfinals

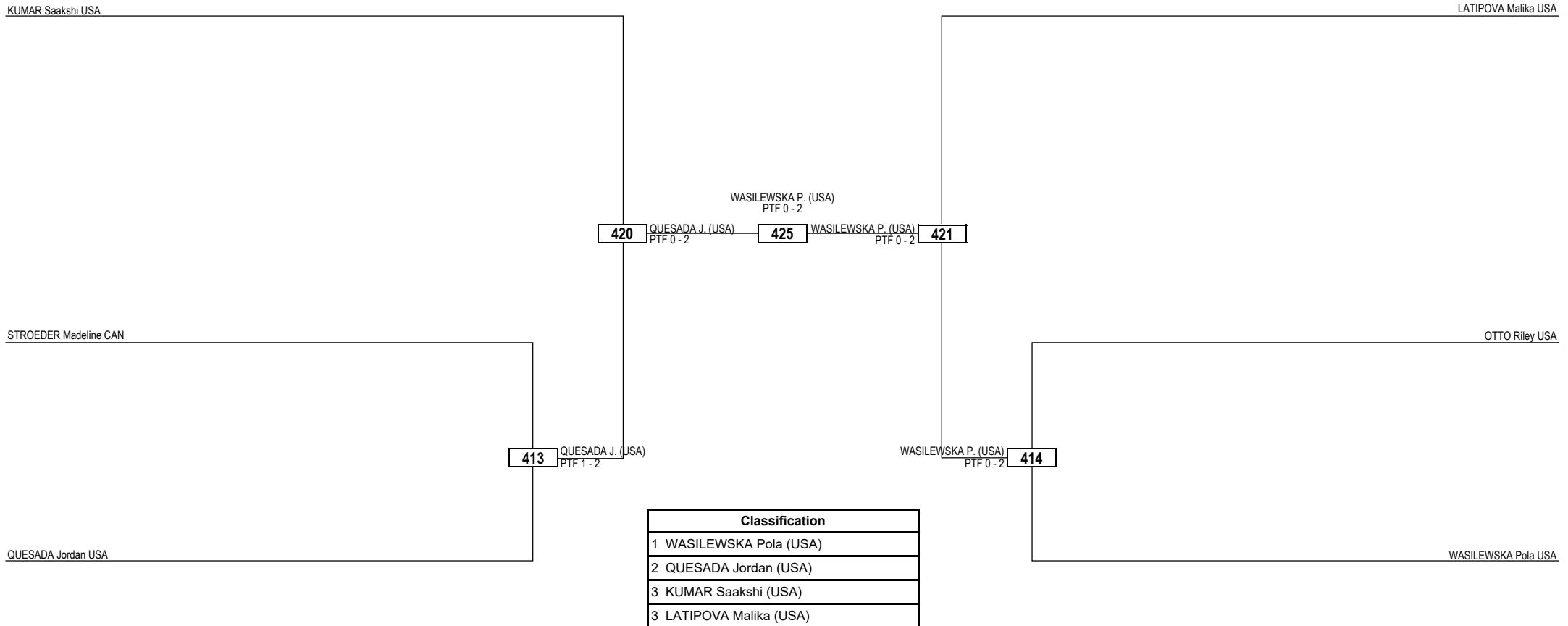

**LEGEND** RSC: Win by Referee Stop Contest    PTG: Win by Point Gap    SUP: Win by Superiority    DSQ: Win by Disqualification    DQB: Win by Disqualification for unsportsmanlike behavior    DWR: Double Withdrawal    R: Round  
 (x) Seed    PTF: Win by Final Score    GDP: Win by Golden Points    WDR: Win by Withdrawal    PUN: Win by Punitive Declaration    DDB: Double Disqualification for unsportsmanlike behavior    DDQ: Double Disqualification





# PanAm Series I

SUN 29 MAY 2022

Black Belt Cadets / Girls -51kg Contestants: 3



	Semifinals	Final	Semifinals
--	------------	-------	------------

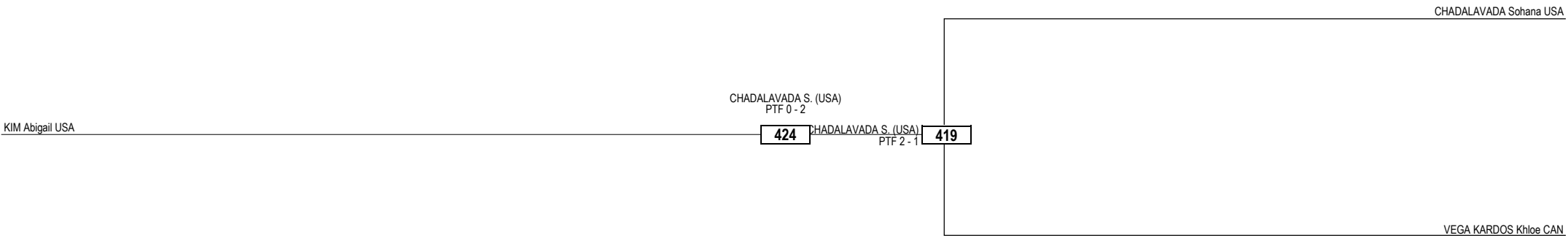

Classification
1 CHADALAVADA Sohana (USA)
2 KIM Abigail (USA)
3 VEGA KARDOS Khloe (CAN)

<b>LEGEND</b>	RSC: Win by Referee Stop Contest	PTG: Win by Point Gap	SUP: Win by Superiority	DSQ: Win by Disqualification	DQB: Win by Disqualification for unsportsmanlike behavior	DWR: Double Withdrawal	R: Round
(x) <b>Seed</b>	PTF: Win by Final Score	GDP: Win by Golden Points	WDR: Win by Withdrawal	PUN: Win by Punitive Declaration	DDB: Double Disqualification for unsportsmanlike behavior	DDQ: Double Disqualification	



# PanAm Series I

SUN 29 MAY 2022

Black Belt Cadets / Girls -44kg Contestants: 10



Round of 16    Quarterfinals    Semifinals    Final    Semifinals    Quarterfinals    Round of 16

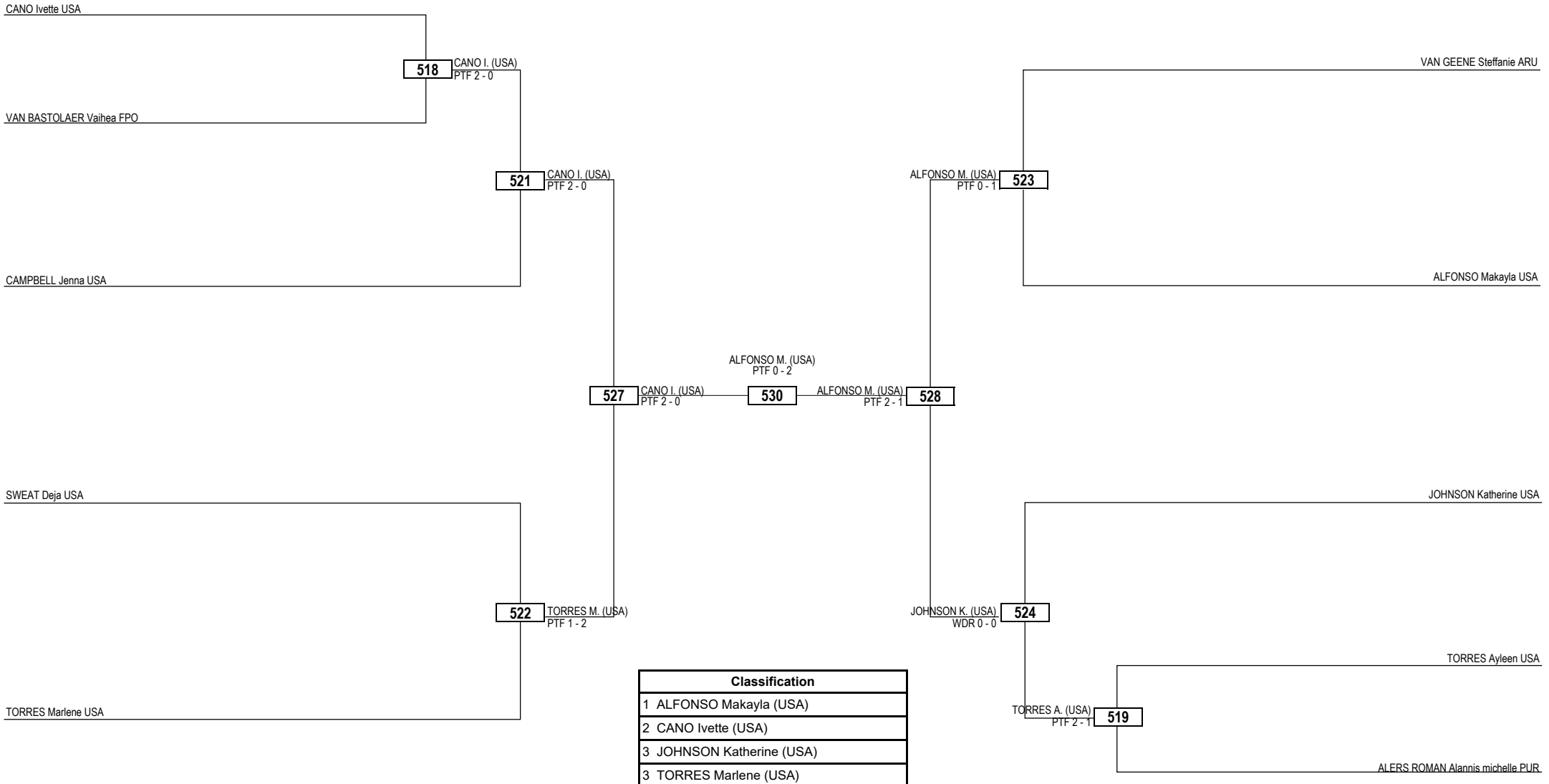

**LEGEND** RSC: Win by Referee Stop Contest    PTG: Win by Point Gap    SUP: Win by Superiority    DSQ: Win by Disqualification    DQB: Win by Disqualification for unsportsmanlike behavior    DWR: Double Withdrawal    R: Round  
**(x) Seed** PTF: Win by Final Score    GDP: Win by Golden Points    WDR: Win by Withdrawal    PUN: Win by Punitive Declaration    DDB: Double Disqualification for unsportsmanlike behavior    DDQ: Double Disqualification



# PanAm Series I

SUN 29 MAY 2022

Black Belt Cadets / Girls -37kg Contestants: 5



Quarterfinals   Semifinals   Final   Semifinals   Quarterfinals

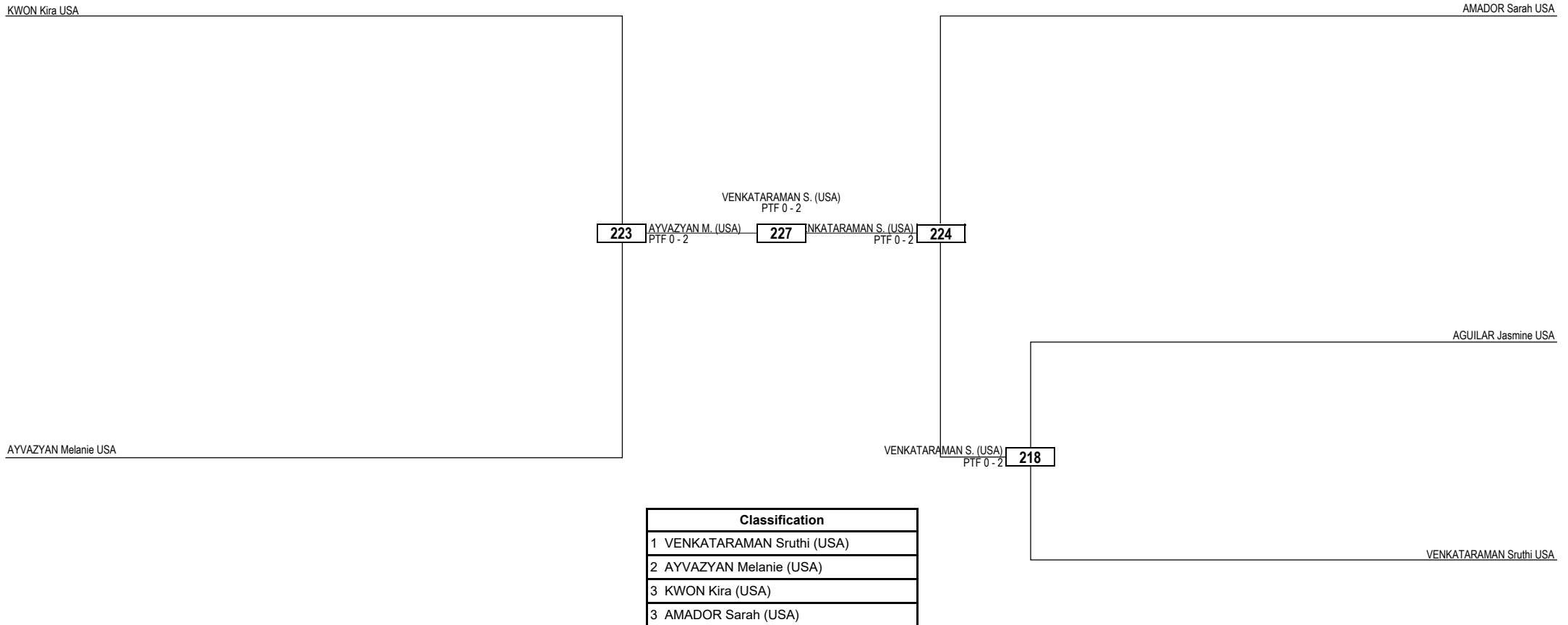

<b>LEGEND</b>	RSC: Win by Referee Stop Contest	PTG: Win by Point Gap	SUP: Win by Superiority	DSQ: Win by Disqualification	DQB: Win by Disqualification for unsportsmanlike behavior	DWR: Double Withdrawal	R: Round
(x) <b>Seed</b>	PTF: Win by Final Score	GDP: Win by Golden Points	WDR: Win by Withdrawal	PUN: Win by Punitive Declaration	DDB: Double Disqualification for unsportsmanlike behavior	DDQ: Double Disqualification	



# PanAm Series I

SUN 29 MAY 2022

Black Belt Cadets / Girls -33kg Contestants: 6



Quarterfinals    Semifinals    Final    Semifinals    Quarterfinals

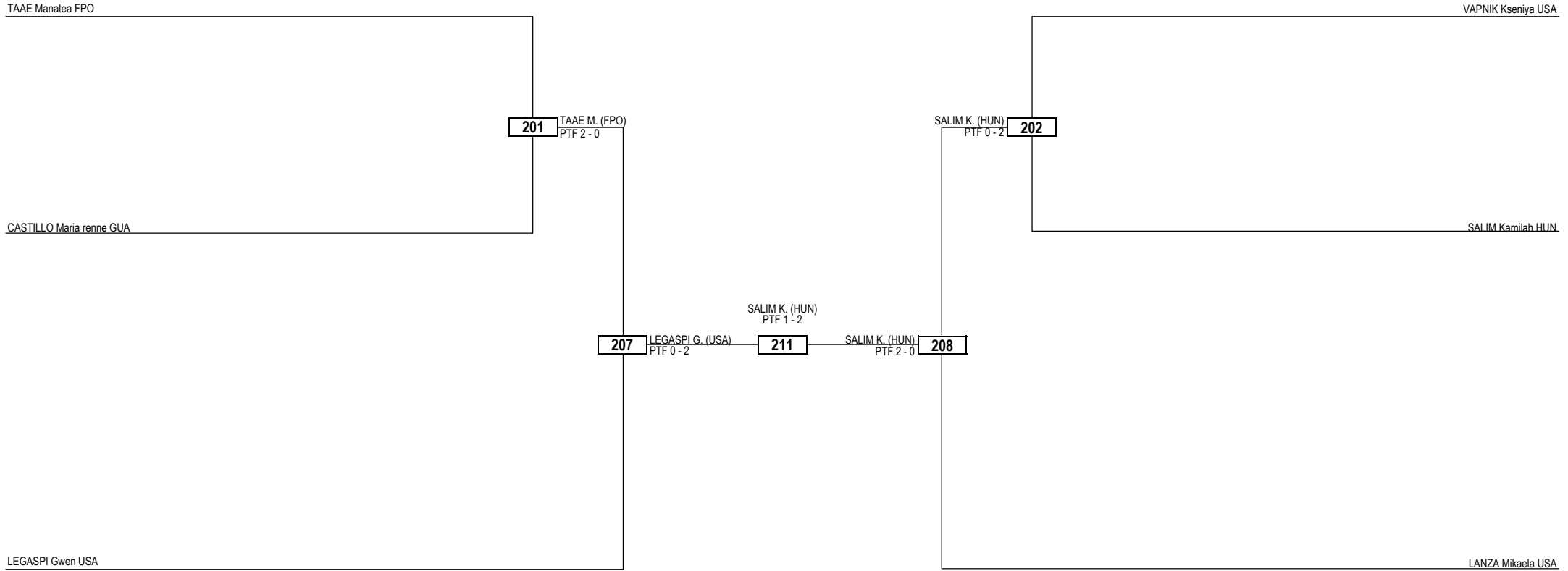

Classification	
1	SALIM Kamilah (HUN)
2	LEGASPI Gwen (USA)
3	TAAE Manatea (FPO)
3	LANZA Mikaela (USA)

<b>LEGEND</b>	RSC: Win by Referee Stop Contest	PTG: Win by Point Gap	SUP: Win by Superiority	DSQ: Win by Disqualification	DQB: Win by Disqualification for unsportsmanlike behavior	DWR: Double Withdrawal	R: Round
(x) <b>Seed</b>	PTF: Win by Final Score	GDP: Win by Golden Points	WDR: Win by Withdrawal	PUN: Win by Punitive Declaration	DDB: Double Disqualification for unsportsmanlike behavior	DDQ: Double Disqualification	



PanAm Series I  
 SUN 29 MAY 2022  
 Black Belt Cadets / Girls +59kg Contestants: 2



Final

MARTINEZ MEJIA Aylin USA

MARTINEZ MEJIA A. (USA)  
 PTF 2 - 0

406

MARTINEZ Ninoshka PUR

Classification
1 MARTINEZ MEJIA Aylin (USA)
2 MARTINEZ Ninoshka (PUR)

<b>LEGEND</b>	RSC: Win by Referee Stop Contest	PTG: Win by Point Gap	SUP: Win by Superiority	DSQ: Win by Disqualification	DQB: Win by Disqualification for unsportsmanlike behavior	DWR: Double Withdrawal	R: Round
<b>(x) Seed</b>	PTF: Win by Final Score	GDP: Win by Golden Points	WDR: Win by Withdrawal	PUN: Win by Punitive Declaration	DDQ: Double Disqualification for unsportsmanlike behavior	DDQ: Double Disqualification	



# PanAm Series I

SUN 29 MAY 2022

Black Belt Juniors / Men -78kg Contestants: 6



Quarterfinals    Semifinals    Final    Semifinals    Quarterfinals

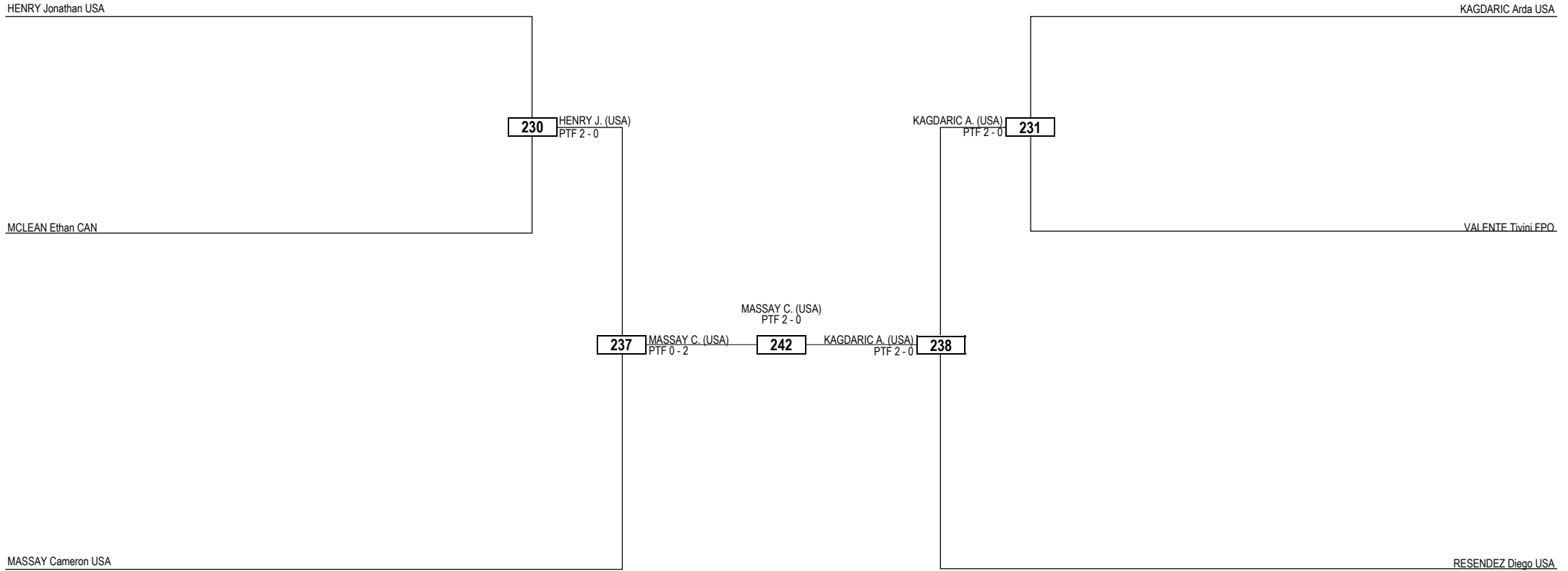

Classification
1 MASSAY Cameron (USA)
2 KAGDARIC Arda (USA)
3 HENRY Jonathan (USA)
3 RESENDEZ Diego (USA)

<b>LEGEND</b>	RSC: Win by Referee Stop Contest	PTG: Win by Point Gap	SUP: Win by Superiority	DSQ: Win by Disqualification	DQB: Win by Disqualification for unsportsmanlike behavior	DWR: Double Withdrawal	R: Round
(x) <b>Seed</b>	PTF: Win by Final Score	GDP: Win by Golden Points	WDR: Win by Withdrawal	PUN: Win by Punitive Declaration	DDB: Double Disqualification for unsportsmanlike behavior	DDQ: Double Disqualification	



# PanAm Series I

SUN 29 MAY 2022

Black Belt Juniors / Men -73kg Contestants: 3



Semifinals

Final

Semifinals

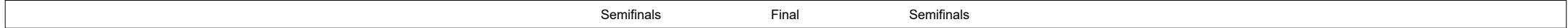

WILCOX Sheldon USA

WILCOX S. (USA)  
PTF 0 - 2

540

WILCOX S. (USA)  
PTF 2 - 0

537

CHUA James USA

OGILVIE Riley USA

Classification
1 WILCOX Sheldon (USA)
2 CHUA James (USA)
3 OGILVIE Riley (USA)

<b>LEGEND</b>	RSC: Win by Referee Stop Contest	PTG: Win by Point Gap	SUP: Win by Superiority	DSQ: Win by Disqualification	DQB: Win by Disqualification for unsportsmanlike behavior	DWR: Double Withdrawal	R: Round
(x) <b>Seed</b>	PTF: Win by Final Score	GDP: Win by Golden Points	WDR: Win by Withdrawal	PUN: Win by Punitive Declaration	DDB: Double Disqualification for unsportsmanlike behavior	DDQ: Double Disqualification	



# PanAm Series I

SUN 29 MAY 2022

Black Belt Juniors / Men -63kg Contestants: 12



Round of 16    Quarterfinals    Semifinals    Final    Semifinals    Quarterfinals    Round of 16

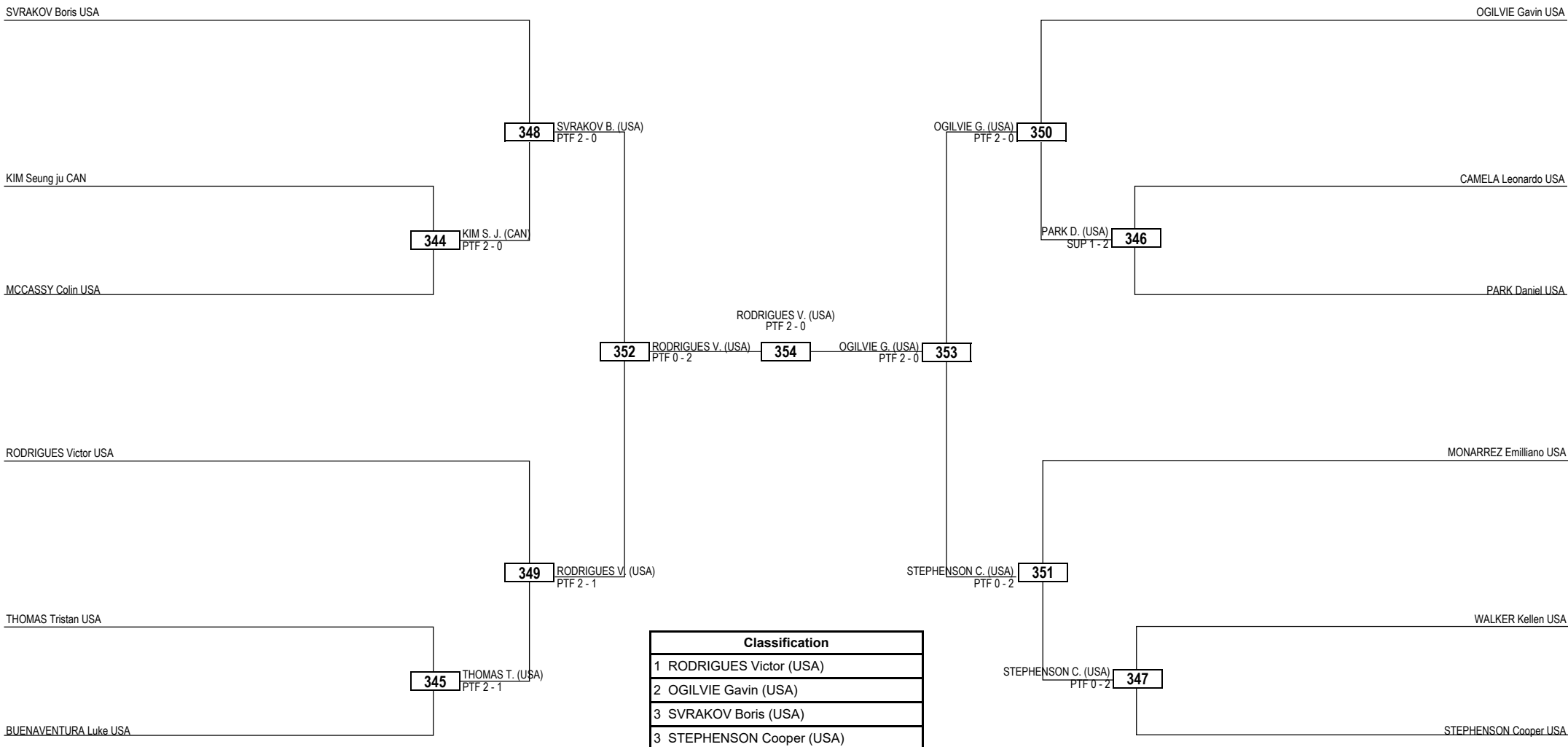

**LEGEND**    RSC: Win by Referee Stop Contest    PTG: Win by Point Gap    SUP: Win by Superiority    DSQ: Win by Disqualification    DQB: Win by Disqualification for unsportsmanlike behavior    DWR: Double Withdrawal    R: Round  
 (x) **Seed**    PTF: Win by Final Score    GDP: Win by Golden Points    WDR: Win by Withdrawal    PUN: Win by Punitive Declaration    DDB: Double Disqualification for unsportsmanlike behavior    DDQ: Double Disqualification





# PanAm Series I

SUN 29 MAY 2022

## Black Belt Juniors / Men -59kg Contestants: 10



Round of 16    Quarterfinals    Semifinals    Final    Semifinals    Quarterfinals    Round of 16

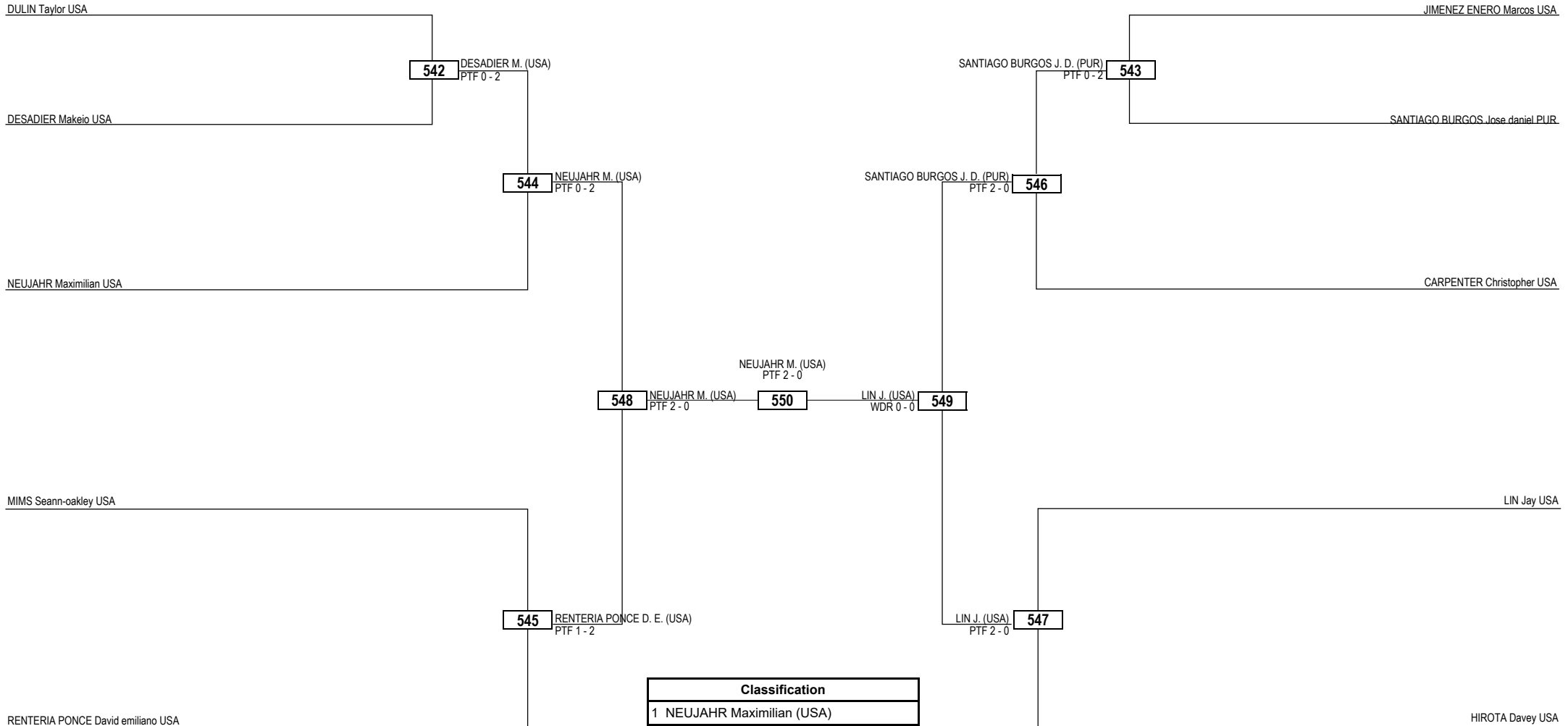

Classification
1 NEUJHR Maximilian (USA)
2 LIN Jay (USA)
3 RENTERIA PONCE David emiliano (USA)
3 SANTIAGO BURGOS Jose daniel (PUR)

**LEGEND** RSC: Win by Referee Stop Contest    PTG: Win by Point Gap    SUP: Win by Superiority    DSQ: Win by Disqualification    DQB: Win by Disqualification for unsportsmanlike behavior    DWR: Double Withdrawal    R: Round  
**(x) Seed** PTF: Win by Final Score    GDP: Win by Golden Points    WDR: Win by Withdrawal    PUN: Win by Punitive Declaration    DDB: Double Disqualification for unsportsmanlike behavior    DDQ: Double Disqualification



# PanAm Series I

SUN 29 MAY 2022

Black Belt Juniors / Men -68kg Contestants: 6



Quarterfinals    Semifinals    Final    Semifinals    Quarterfinals

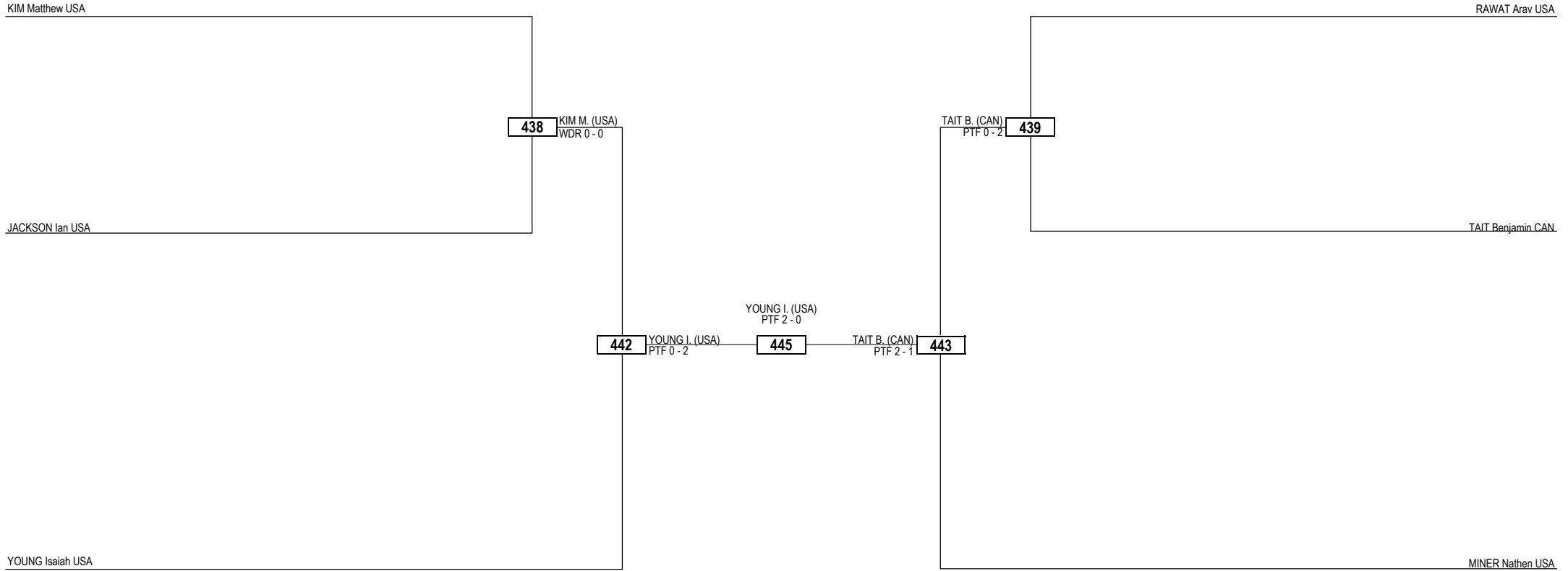

Classification
1 YOUNG Isaiah (USA)
2 TAIT Benjamin (CAN)
3 KIM Matthew (USA)
3 MINER Nathen (USA)

<b>LEGEND</b>	RSC: Win by Referee Stop Contest	PTG: Win by Point Gap	SUP: Win by Superiority	DSQ: Win by Disqualification	DQB: Win by Disqualification for unsportsmanlike behavior	DWR: Double Withdrawal	R: Round
(x) <b>Seed</b>	PTF: Win by Final Score	GDP: Win by Golden Points	WDR: Win by Withdrawal	PUN: Win by Punitive Declaration	DDB: Double Disqualification for unsportsmanlike behavior	DDQ: Double Disqualification	



# PanAm Series I

SUN 29 MAY 2022

Black Belt Juniors / Men -51kg Contestants: 13



Round of 16    Quarterfinals    Semifinals    Final    Semifinals    Quarterfinals    Round of 16

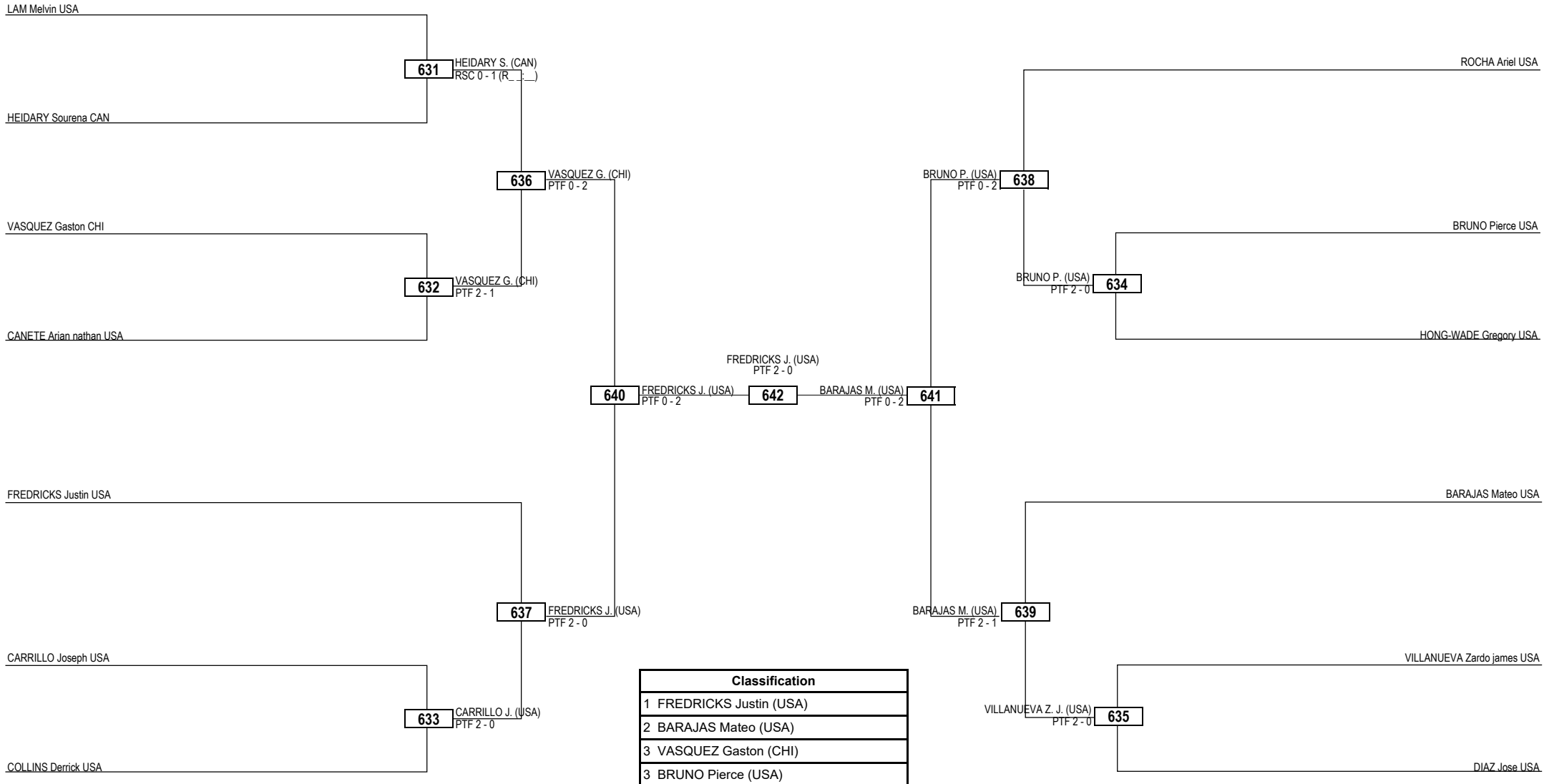

**LEGEND** RSC: Win by Referee Stop Contest    PTG: Win by Point Gap    SUP: Win by Superiority    DSQ: Win by Disqualification    DQB: Win by Disqualification for unsportsmanlike behavior    DWR: Double Withdrawal    R: Round  
**(x) Seed** PTF: Win by Final Score    GDP: Win by Golden Points    WDR: Win by Withdrawal    PUN: Win by Punitive Declaration    DDB: Double Disqualification for unsportsmanlike behavior    DDQ: Double Disqualification



# PanAm Series I

SUN 29 MAY 2022

Black Belt Juniors / Men -48kg Contestants: 6



Quarterfinals   Semifinals   Final   Semifinals   Quarterfinals

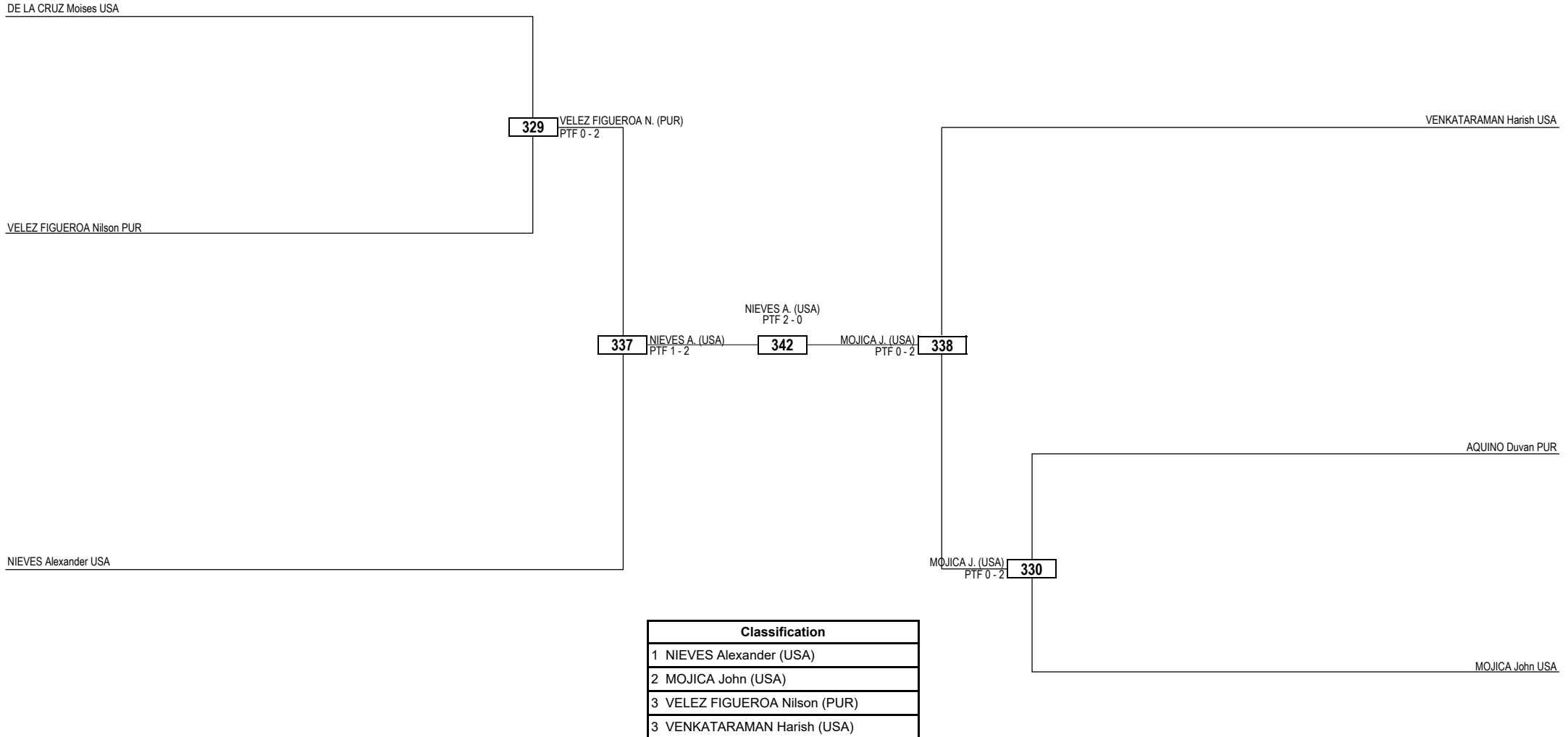

<b>LEGEND</b>	RSC: Win by Referee Stop Contest	PTG: Win by Point Gap	SUP: Win by Superiority	DSQ: Win by Disqualification	DQB: Win by Disqualification for unsportsmanlike behavior	DWR: Double Withdrawal	R: Round
(x) <b>Seed</b>	PTF: Win by Final Score	GDP: Win by Golden Points	WDR: Win by Withdrawal	PUN: Win by Punitive Declaration	DDB: Double Disqualification for unsportsmanlike behavior	DDQ: Double Disqualification	



# PanAm Series I

SUN 29 MAY 2022

Black Belt Juniors / Men -45kg Contestants: 10



Round of 16    Quarterfinals    Semifinals    Final    Semifinals    Quarterfinals    Round of 16

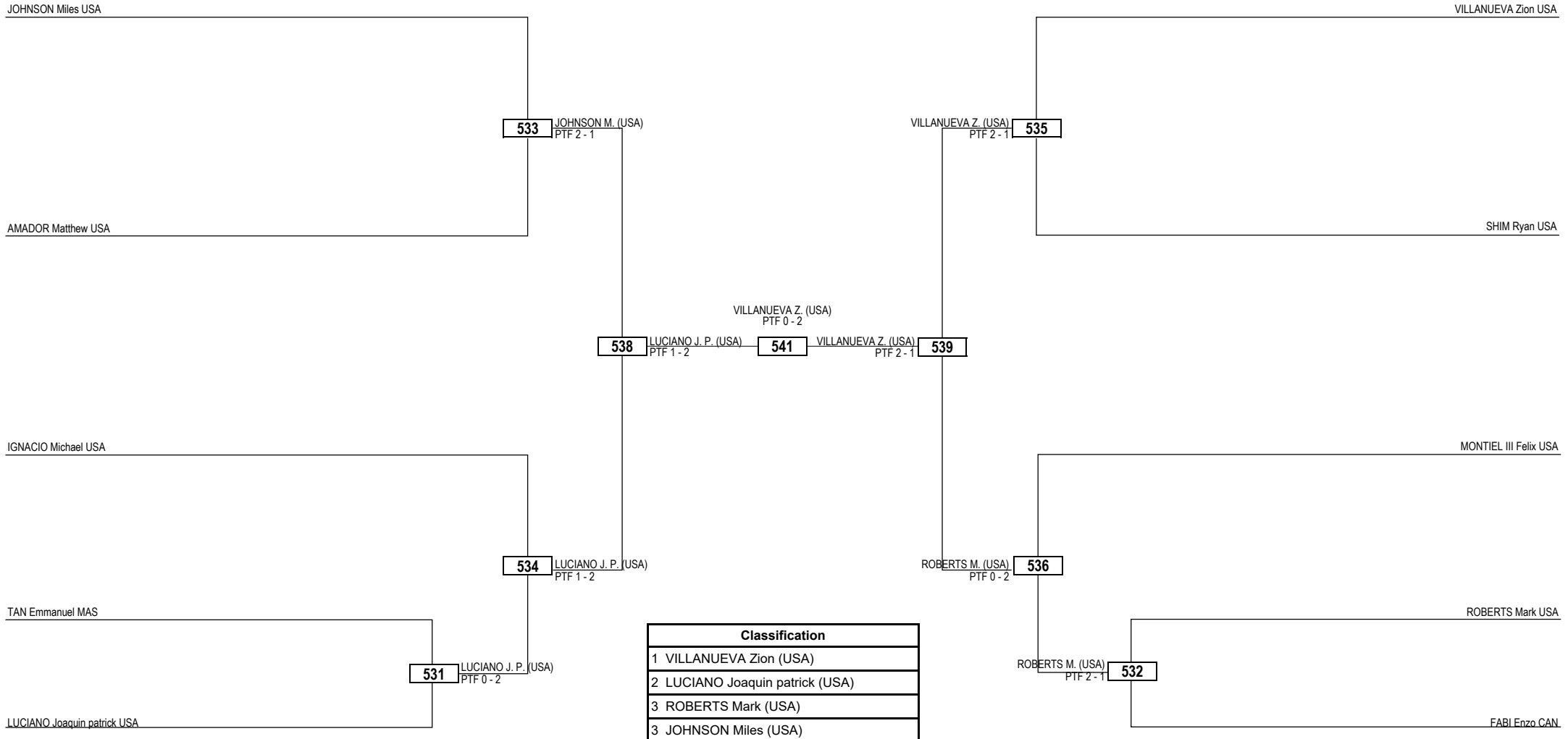

**LEGEND**    RSC: Win by Referee Stop Contest    PTG: Win by Point Gap    SUP: Win by Superiority    DSQ: Win by Disqualification    DQB: Win by Disqualification for unsportsmanlike behavior    DWR: Double Withdrawal    R: Round  
**(x) Seed**    PTF: Win by Final Score    GDP: Win by Golden Points    WDR: Win by Withdrawal    PUN: Win by Punitive Declaration    DDB: Double Disqualification for unsportsmanlike behavior    DDQ: Double Disqualification



# PanAm Series I

SUN 29 MAY 2022

Black Belt Juniors / Men +78kg Contestants: 5



Quarterfinals   Semifinals   Final   Semifinals   Quarterfinals

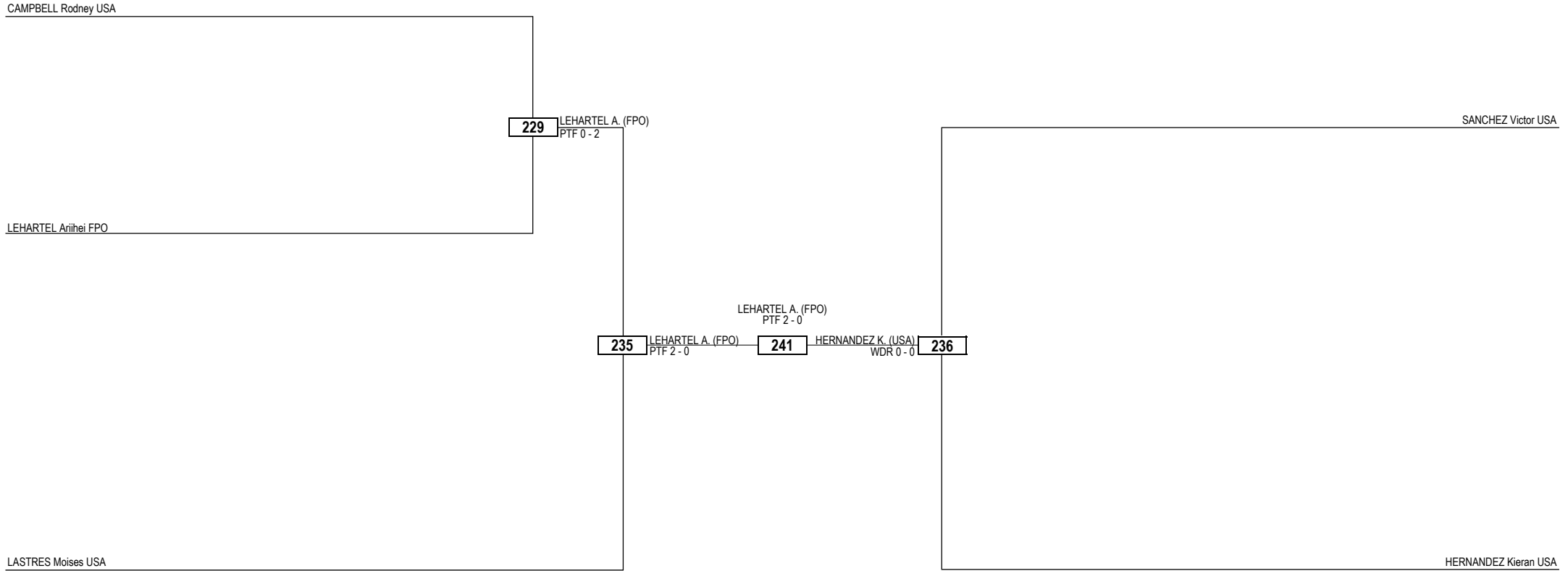

Classification
1 LEHARTEL Ariihei (FPO)
2 HERNANDEZ Kieran (USA)
3 LASTRES Moises (USA)
3 SANCHEZ Victor (USA)

<b>LEGEND</b>	RSC: Win by Referee Stop Contest	PTG: Win by Point Gap	SUP: Win by Superiority	DSQ: Win by Disqualification	DQB: Win by Disqualification for unsportsmanlike behavior	DWR: Double Withdrawal	R: Round
(x) <b>Seed</b>	PTF: Win by Final Score	GDP: Win by Golden Points	WDR: Win by Withdrawal	PUN: Win by Punitive Declaration	DDB: Double Disqualification for unsportsmanlike behavior	DDQ: Double Disqualification	



# PanAm Series I

SUN 29 MAY 2022

Black Belt Juniors / Men -55kg Contestants: 9



Round of 16    Quarterfinals    Semifinals    Final    Semifinals    Quarterfinals    Round of 16

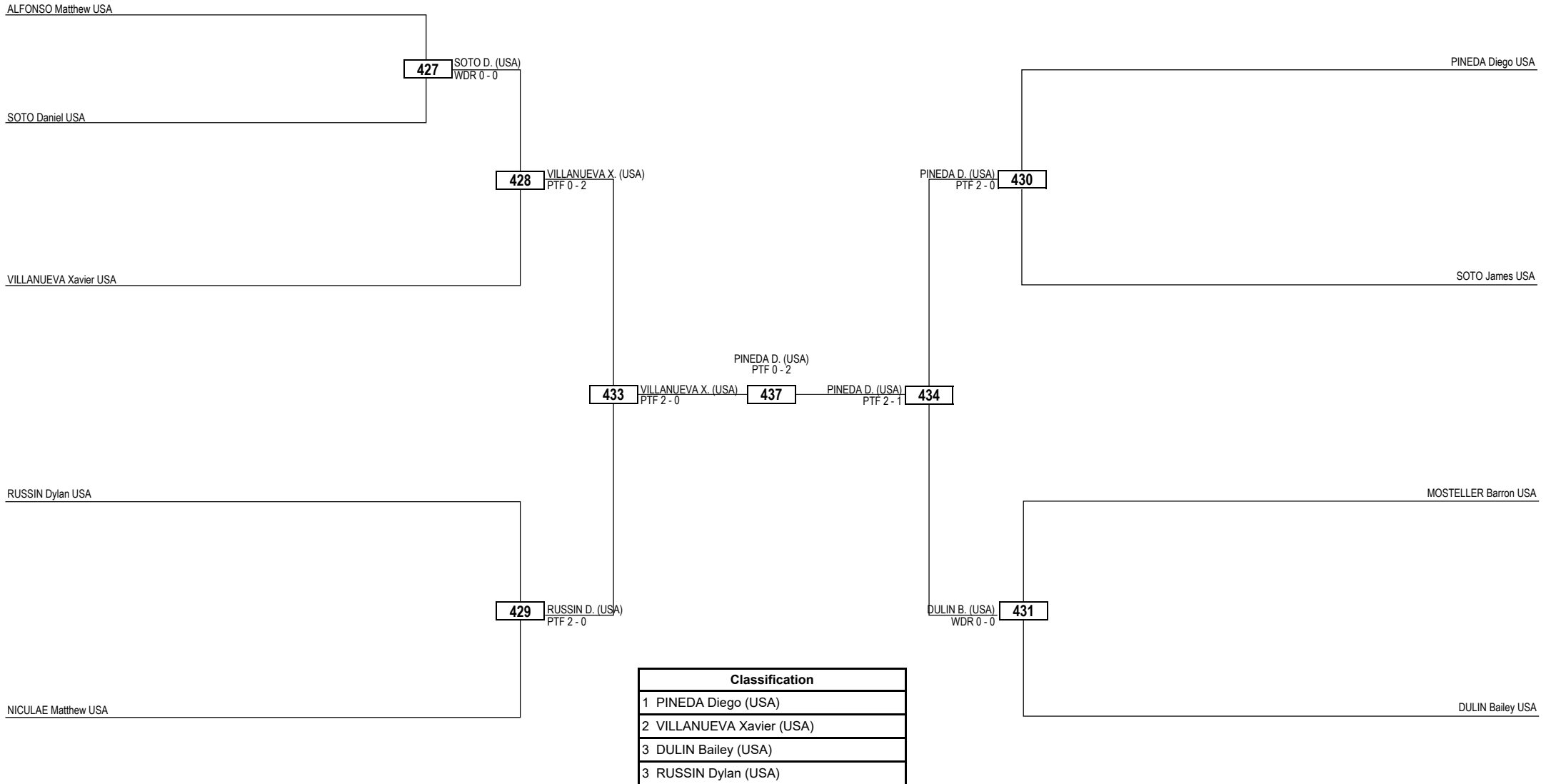

<b>LEGEND</b>	RSC: Win by Referee Stop Contest	PTG: Win by Point Gap	SUP: Win by Superiority	DSQ: Win by Disqualification	DQB: Win by Disqualification for unsportsmanlike behavior	DWR: Double Withdrawal	R: Round
(x) <b>Seed</b>	PTF: Win by Final Score	GDP: Win by Golden Points	WDR: Win by Withdrawal	PUN: Win by Punitive Declaration	DDB: Double Disqualification for unsportsmanlike behavior	DDQ: Double Disqualification	



# PanAm Series I

SUN 29 MAY 2022

Black Belt Juniors / Women -63kg Contestants: 4



Semifinals

Final

Semifinals

AMIRKHANYAN Mia USA

MARCHLINSKI Maria USA

AMIRKHANYAN M. (USA)  
PTF 2 - 1

335

AMIRKHANYAN M. (USA)  
PTF 2 - 1

341

MARCHLINSKI M. (USA)  
PTF 2 - 0

336

BARRON Courtney USA

TYLER Marissa USA

Classification
1 AMIRKHANYAN Mia (USA)
2 MARCHLINSKI Maria (USA)
3 BARRON Courtney (USA)
3 TYLER Marissa (USA)

**LEGEND** RSC: Win by Referee Stop Contest  
(x) **Seed** PTF: Win by Final Score

PTG: Win by Point Gap  
GDP: Win by Golden Points

SUP: Win by Superiority  
WDR: Win by Withdrawal

DSQ: Win by Disqualification  
PUN: Win by Punitive Declaration

DQB: Win by Disqualification for unsportsmanlike behavior  
DDB: Double Disqualification for unsportsmanlike behavior

DWR: Double Withdrawal  
DDQ: Double Disqualification

R: Round





# PanAm Series I

SUN 29 MAY 2022

Black Belt Juniors / Women +68kg Contestants: 7



Quarterfinals    Semifinals    Final    Semifinals    Quarterfinals

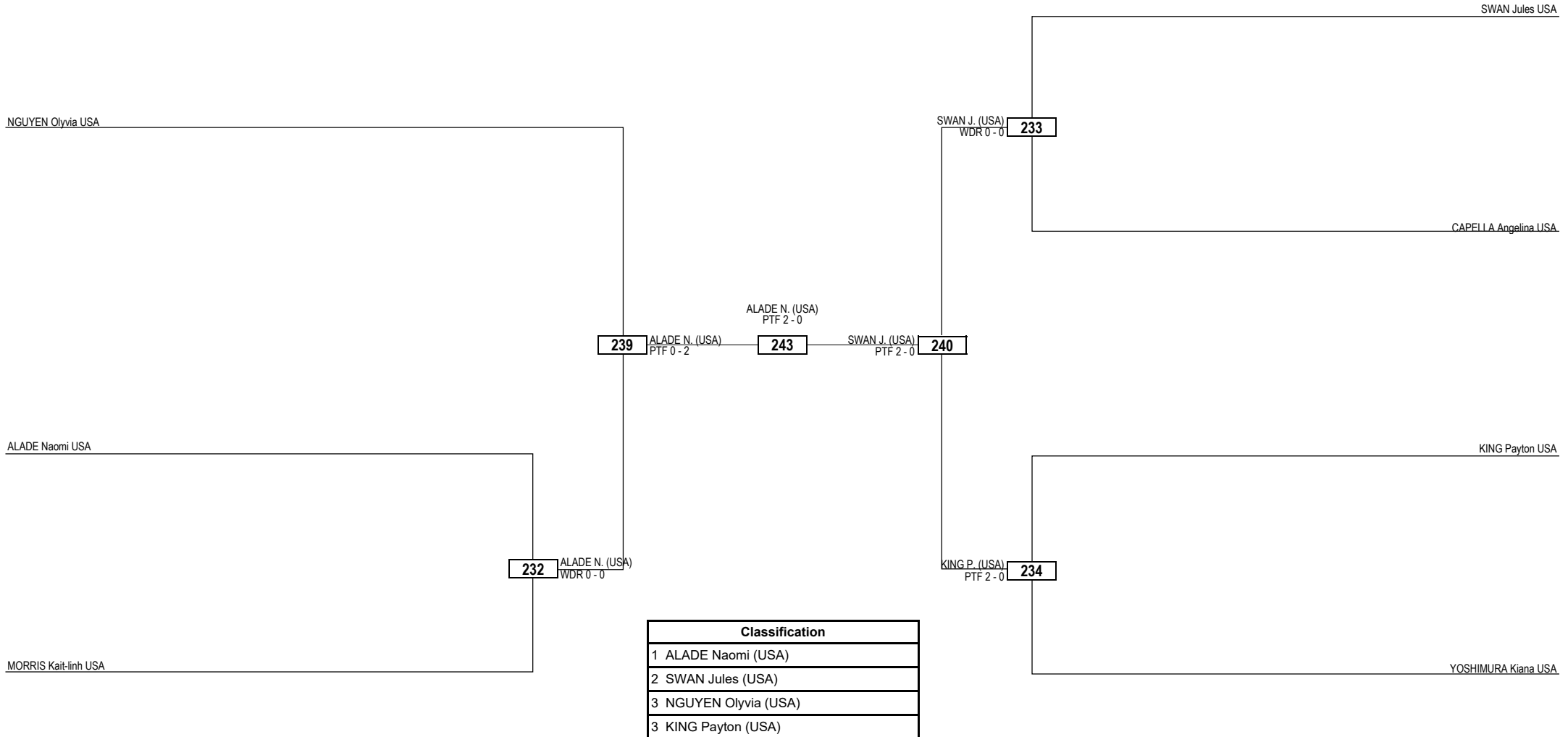

Classification
1 ALADE Naomi (USA)
2 SWAN Jules (USA)
3 NGUYEN Olyvia (USA)
3 KING Payton (USA)

**LEGEND** RSC: Win by Referee Stop Contest    PTG: Win by Point Gap    SUP: Win by Superiority    DSQ: Win by Disqualification    DQB: Win by Disqualification for unsportsmanlike behavior    DWR: Double Withdrawal    R: Round  
**(x) Seed** PTF: Win by Final Score    GDP: Win by Golden Points    WDR: Win by Withdrawal    PUN: Win by Punitive Declaration    DDB: Double Disqualification for unsportsmanlike behavior    DDQ: Double Disqualification



# PanAm Series I

SUN 29 MAY 2022

Black Belt Juniors / Women -42kg Contestants: 5



Quarterfinals    Semifinals    Final    Semifinals    Quarterfinals

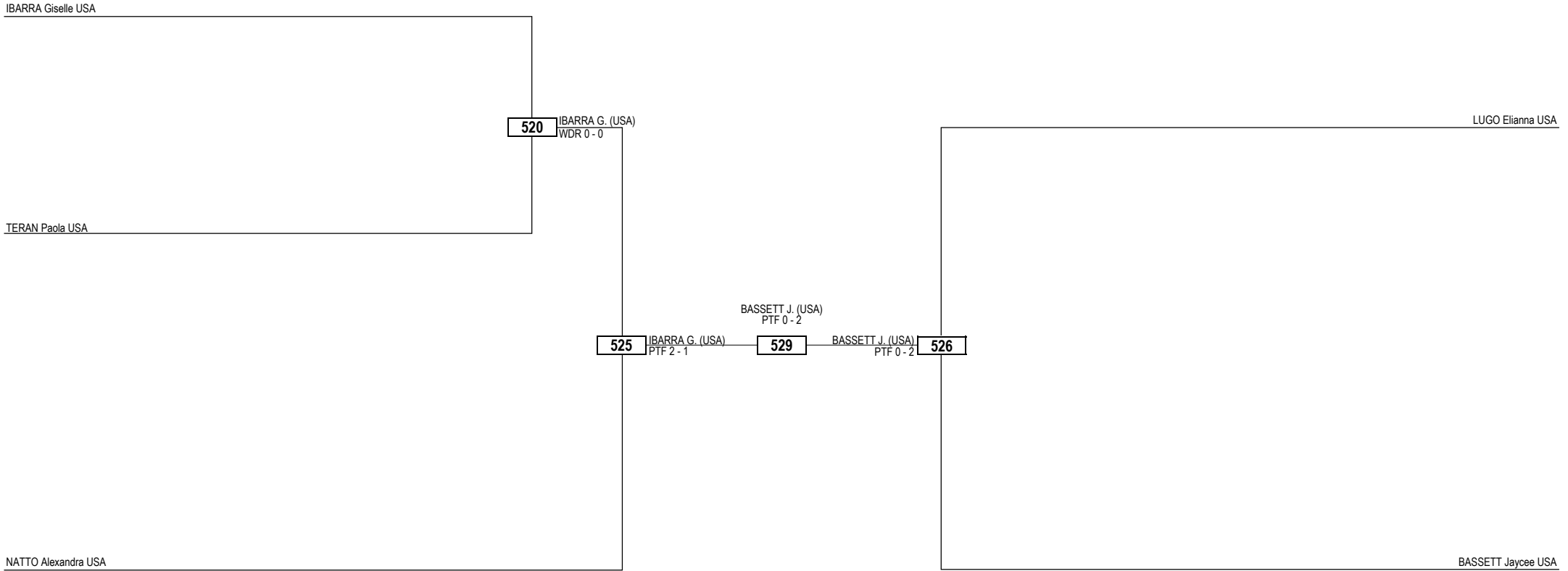

Classification
1 BASSETT Jaycee (USA)
2 IBARRA Giselle (USA)
3 NATTO Alexandra (USA)
3 LUGO Elianna (USA)

<b>LEGEND</b>	RSC: Win by Referee Stop Contest	PTG: Win by Point Gap	SUP: Win by Superiority	DSQ: Win by Disqualification	DQB: Win by Disqualification for unsportsmanlike behavior	DWR: Double Withdrawal	R: Round
(x) <b>Seed</b>	PTF: Win by Final Score	GDP: Win by Golden Points	WDR: Win by Withdrawal	PUN: Win by Punitive Declaration	DDB: Double Disqualification for unsportsmanlike behavior	DDQ: Double Disqualification	



# PanAm Series I

SUN 29 MAY 2022

Black Belt Juniors / Women -44kg Contestants: 7



Quarterfinals   Semifinals   Final   Semifinals   Quarterfinals

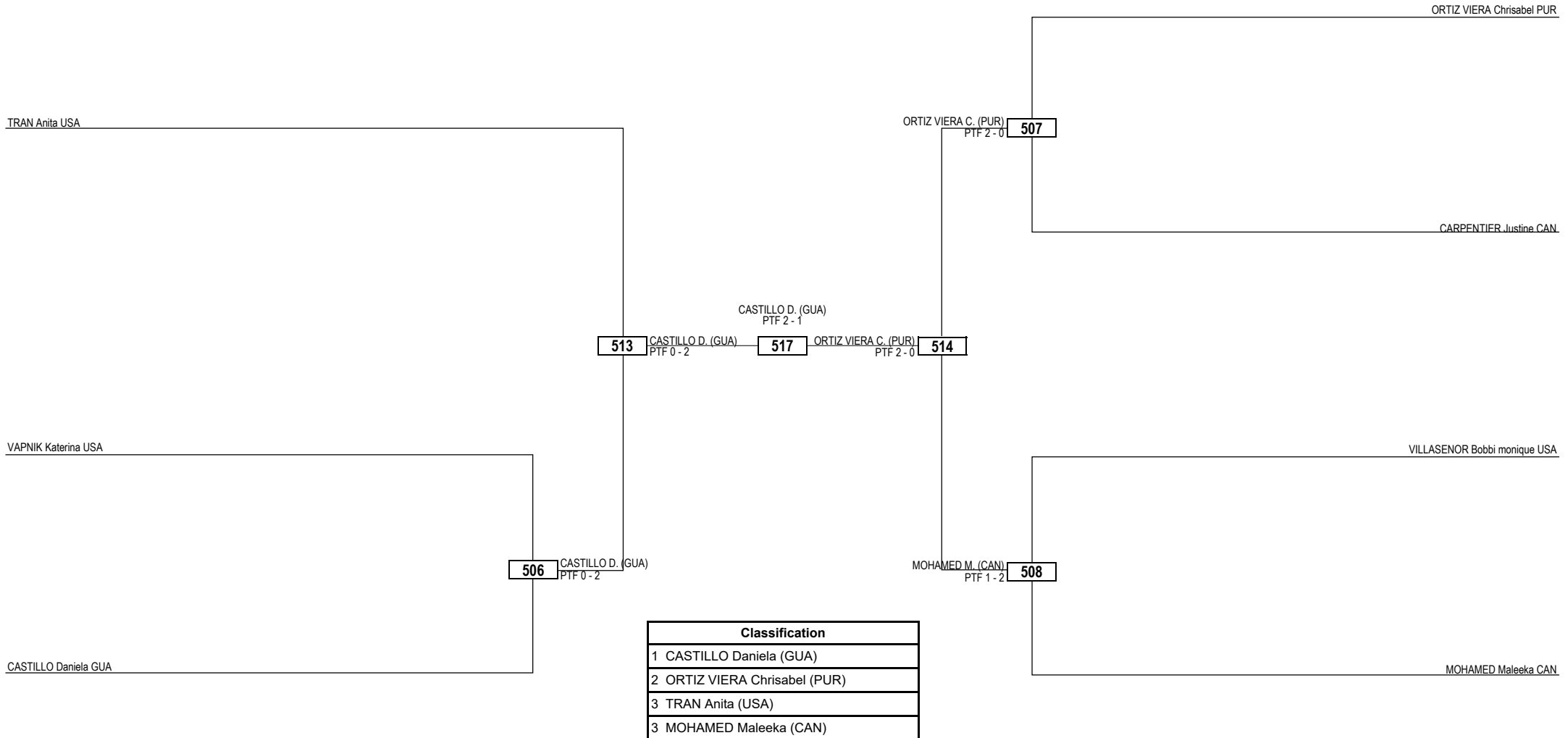

<b>LEGEND</b>	RSC: Win by Referee Stop Contest	PTG: Win by Point Gap	SUP: Win by Superiority	DSQ: Win by Disqualification	DQB: Win by Disqualification for unsportsmanlike behavior	DWR: Double Withdrawal	R: Round
<b>(x) Seed</b>	PTF: Win by Final Score	GDP: Win by Golden Points	WDR: Win by Withdrawal	PUN: Win by Punitive Declaration	DDB: Double Disqualification for unsportsmanlike behavior	DDQ: Double Disqualification	



# PanAm Series I

SUN 29 MAY 2022

## Black Belt Juniors / Women -49kg Contestants: 10



Round of 16    Quarterfinals    Semifinals    Final    Semifinals    Quarterfinals    Round of 16

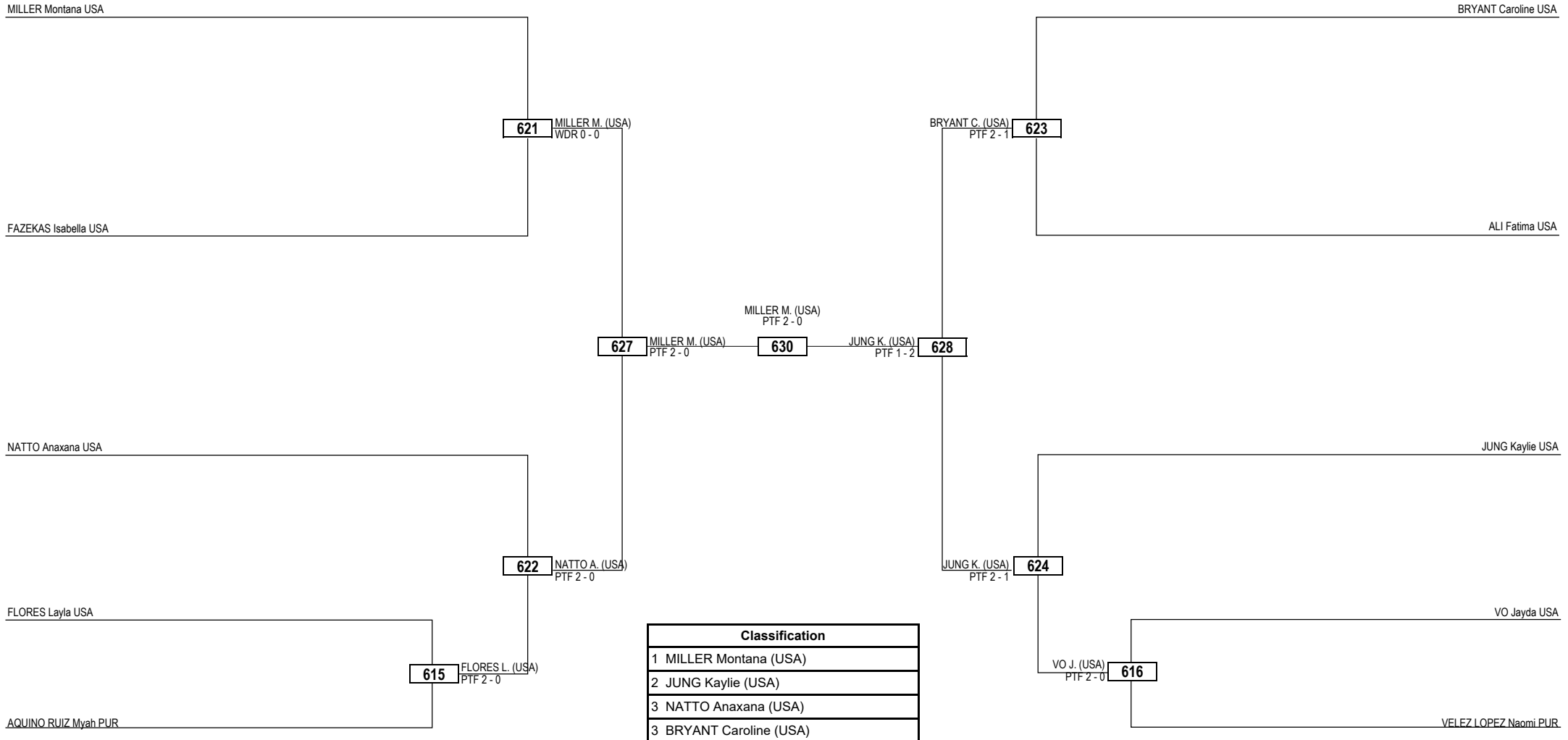

**LEGEND** RSC: Win by Referee Stop Contest    PTG: Win by Point Gap    SUP: Win by Superiority    DSQ: Win by Disqualification    DQB: Win by Disqualification for unsportsmanlike behavior    DWR: Double Withdrawal    R: Round  
 (x) Seed    PTF: Win by Final Score    GDP: Win by Golden Points    WDR: Win by Withdrawal    PUN: Win by Punitive Declaration    DDB: Double Disqualification for unsportsmanlike behavior    DDQ: Double Disqualification



# PanAm Series I

SUN 29 MAY 2022

Black Belt Juniors / Women -52kg Contestants: 7



Quarterfinals   Semifinals   Final   Semifinals   Quarterfinals

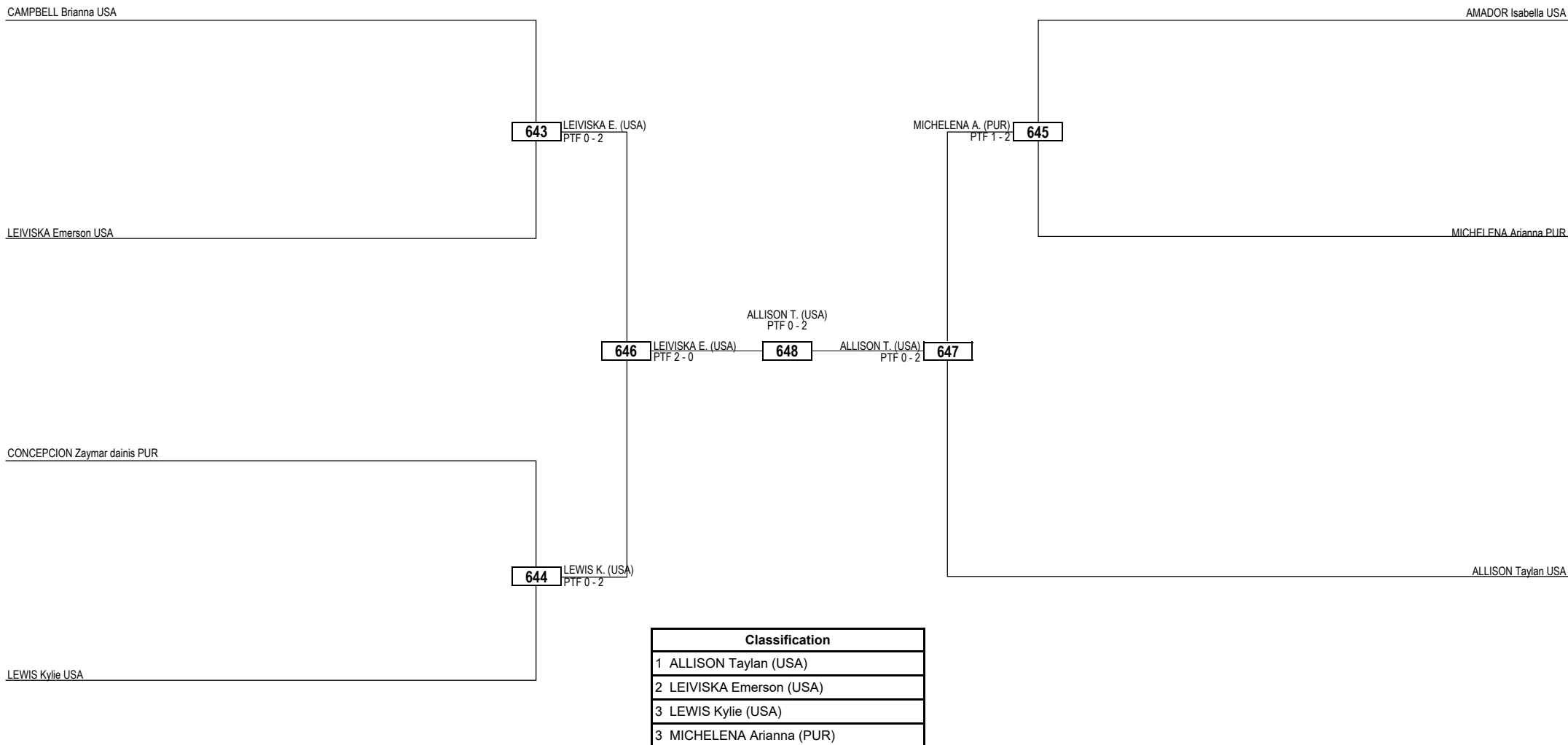

<b>LEGEND</b>	RSC: Win by Referee Stop Contest	PTG: Win by Point Gap	SUP: Win by Superiority	DSQ: Win by Disqualification	DQB: Win by Disqualification for unsportsmanlike behavior	DWR: Double Withdrawal	R: Round
<b>(x) Seed</b>	PTF: Win by Final Score	GDP: Win by Golden Points	WDR: Win by Withdrawal	PUN: Win by Punitive Declaration	DDB: Double Disqualification for unsportsmanlike behavior	DDQ: Double Disqualification	



# PanAm Series I

SUN 29 MAY 2022

## Black Belt Juniors / Women -55kg Contestants: 10



Round of 16    Quarterfinals    Semifinals    Final    Semifinals    Quarterfinals    Round of 16

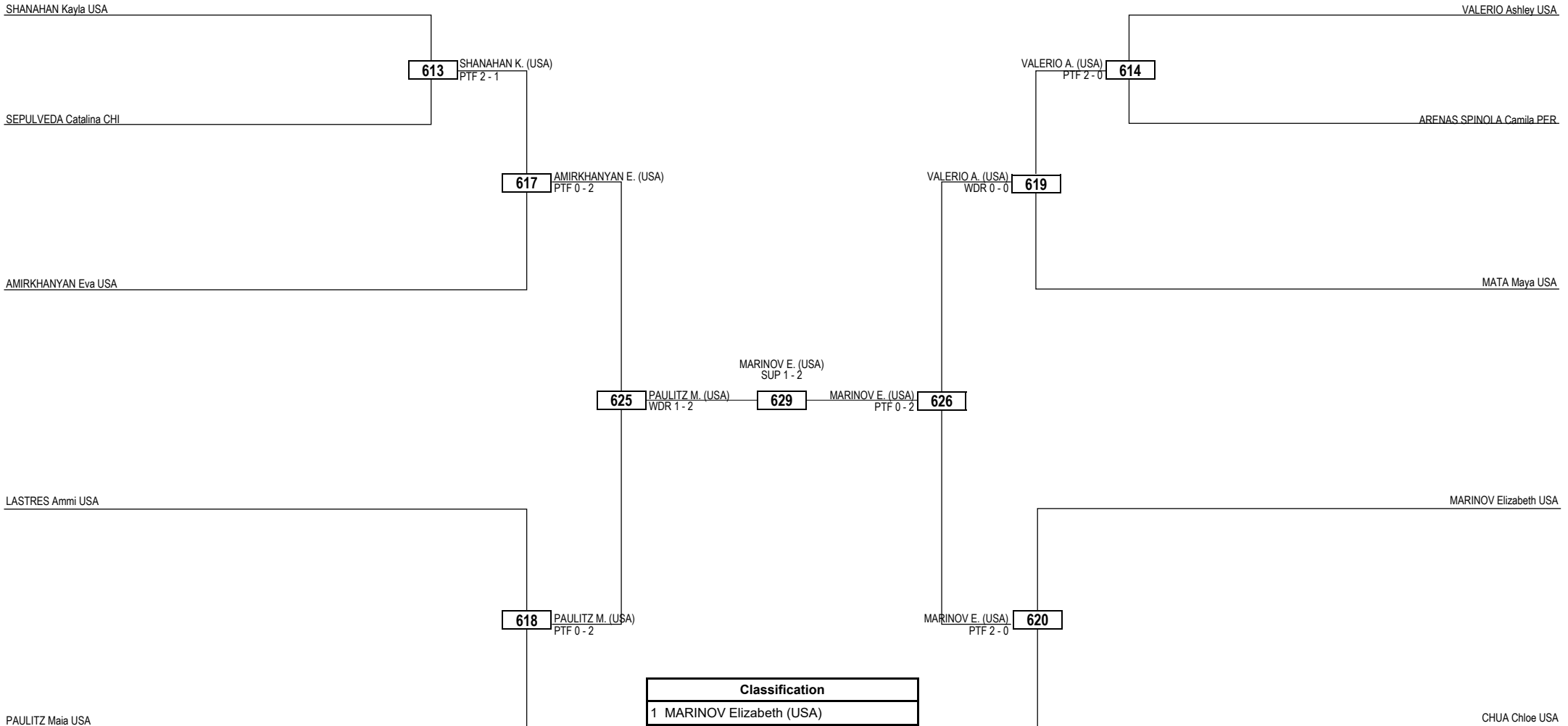

Classification
1 MARINOV Elizabeth (USA)
2 PAULITZ Maia (USA)
3 VALERIO Ashley (USA)
3 AMIRKHANYAN Eva (USA)

**LEGEND** RSC: Win by Referee Stop Contest    PTG: Win by Point Gap    SUP: Win by Superiority    DSQ: Win by Disqualification    DQB: Win by Disqualification for unsportsmanlike behavior    DWR: Double Withdrawal    R: Round  
 (x) Seed    PTF: Win by Final Score    GDP: Win by Golden Points    WDR: Win by Withdrawal    PUN: Win by Punitive Declaration    DDB: Double Disqualification for unsportsmanlike behavior    DDQ: Double Disqualification



# PanAm Series I

SUN 29 MAY 2022

Black Belt Juniors / Women -59kg Contestants: 8



Quarterfinals   Semifinals   Final   Semifinals   Quarterfinals

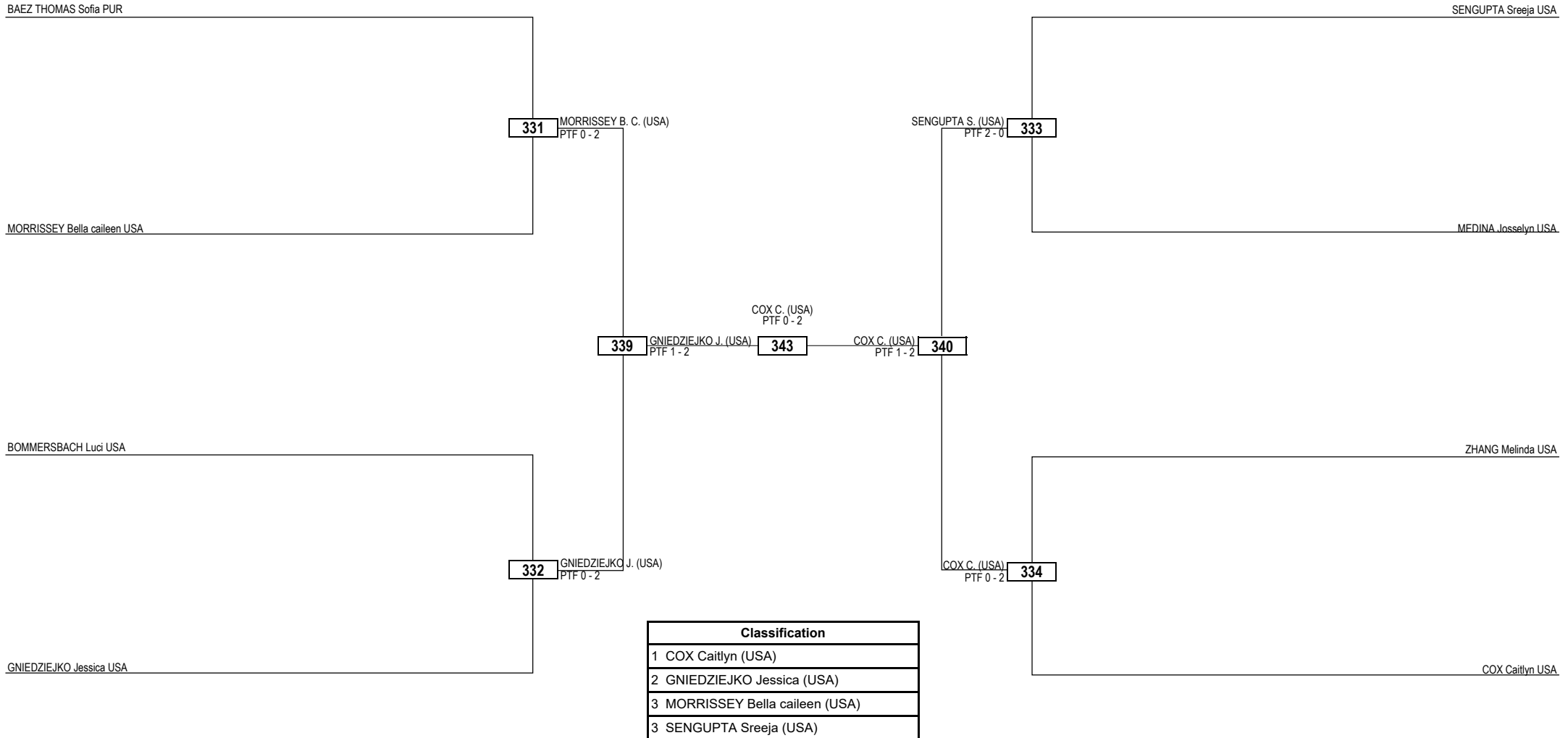

**LEGEND** RSC: Win by Referee Stop Contest    PTG: Win by Point Gap    SUP: Win by Superiority    DSQ: Win by Disqualification    DQB: Win by Disqualification for unsportsmanlike behavior    DWR: Double Withdrawal    R: Round  
**(x) Seed**    PTF: Win by Final Score    GDP: Win by Golden Points    WDR: Win by Withdrawal    PUN: Win by Punitive Declaration    DDB: Double Disqualification for unsportsmanlike behavior    DDQ: Double Disqualification



# PanAm Series I

SUN 29 MAY 2022

Black Belt Juniors / Women -68kg Contestants: 4



Semifinals

Final

Semifinals

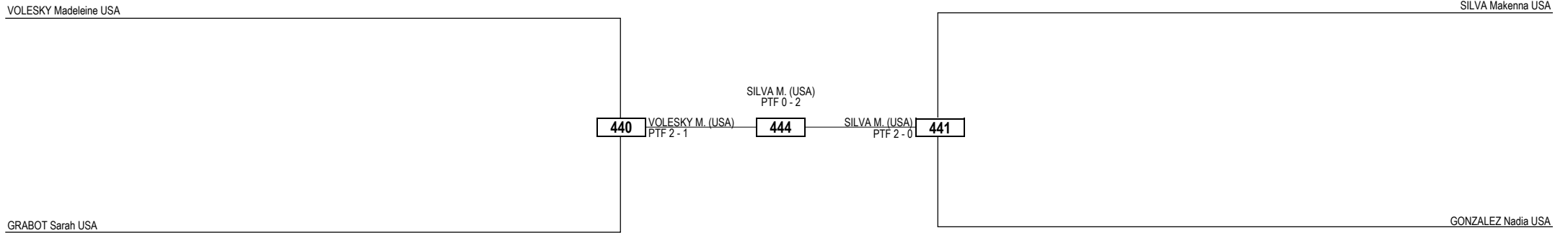

Classification
1 SILVA Makenna (USA)
2 VOLESKY Madeleine (USA)
3 GONZALEZ Nadia (USA)
3 GRABOT Sarah (USA)

<b>LEGEND</b>	RSC: Win by Referee Stop Contest	PTG: Win by Point Gap	SUP: Win by Superiority	DSQ: Win by Disqualification	DQB: Win by Disqualification for unsportsmanlike behavior	DWR: Double Withdrawal	R: Round
(x) <b>Seed</b>	PTF: Win by Final Score	GDP: Win by Golden Points	WDR: Win by Withdrawal	PUN: Win by Punitive Declaration	DDB: Double Disqualification for unsportsmanlike behavior	DDQ: Double Disqualification	





# PanAm Series I

SUN 29 MAY 2022

Black Belt Juniors / Women -46kg Contestants: 6



Quarterfinals   Semifinals   Final   Semifinals   Quarterfinals

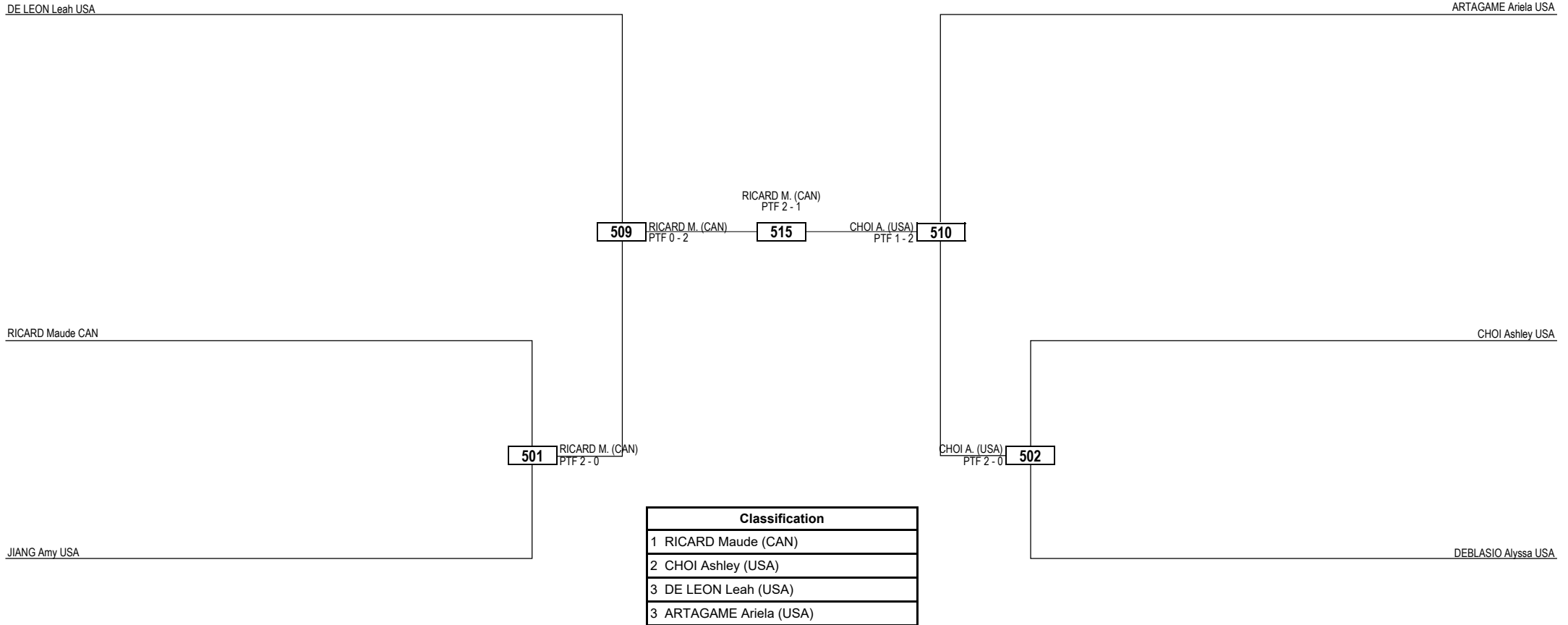

**LEGEND** RSC: Win by Referee Stop Contest    PTG: Win by Point Gap    SUP: Win by Superiority    DSQ: Win by Disqualification    DQB: Win by Disqualification for unsportsmanlike behavior    DWR: Double Withdrawal    R: Round  
 (x) Seed    PTF: Win by Final Score    GDP: Win by Golden Points    WDR: Win by Withdrawal    PUN: Win by Punitive Declaration    DDB: Double Disqualification for unsportsmanlike behavior    DDQ: Double Disqualification



# PanAm Series I

SUN 29 MAY 2022

Red Belt Cadets / Boys -53kg Contestants: 3



Semifinals

Final

Semifinals

TORRES Brendan USA

SULTAN X. (USA)  
PTF 0 - 2

436

SULTAN X. (USA)  
PTF 0 - 2

432

ECHEVARRIA Alejandro USA

SULTAN Xavier USA

Classification
1 SULTAN Xavier (USA)
2 TORRES Brendan (USA)
3 ECHEVARRIA Alejandro (USA)

<b>LEGEND</b>	RSC: Win by Referee Stop Contest	PTG: Win by Point Gap	SUP: Win by Superiority	DSQ: Win by Disqualification	DQB: Win by Disqualification for unsportsmanlike behavior	DWR: Double Withdrawal	R: Round
(x) <b>Seed</b>	PTF: Win by Final Score	GDP: Win by Golden Points	WDR: Win by Withdrawal	PUN: Win by Punitive Declaration	DDB: Double Disqualification for unsportsmanlike behavior	DDQ: Double Disqualification	



PanAm Series I  
 SUN 29 MAY 2022  
 Red Belt Cadets / Boys -49kg Contestants: 2



Final

MEJIA Yair hank USA

LOPEZ H. (USA)  
 PTF 0 - 2

435

LOPEZ Hamilton USA

Classification
1 LOPEZ Hamilton (USA)
2 MEJIA Yair hank (USA)

<b>LEGEND</b>	RSC: Win by Referee Stop Contest	PTG: Win by Point Gap	SUP: Win by Superiority	DSQ: Win by Disqualification	DQB: Win by Disqualification for unsportsmanlike behavior	DWR: Double Withdrawal	R: Round
(x) <b>Seed</b>	PTF: Win by Final Score	GDP: Win by Golden Points	WDR: Win by Withdrawal	PUN: Win by Punitive Declaration	DDQ: Double Disqualification for unsportsmanlike behavior	DDQ: Double Disqualification	